

Transformer, BERT

Milan Straka

 April 25, 2022



EUROPEAN UNION
European Structural and Investment Fund
Operational Programme Research,
Development and Education

Charles University in Prague
Faculty of Mathematics and Physics
Institute of Formal and Applied Linguistics



unless otherwise stated

Attention is All You Need

For some sequence processing tasks, *sequential* processing (as performed by recurrent neural networks) of its elements might be too restrictive.

Instead, we may want to be able to combine sequence elements independently on their distance.

Such processing is allowed in the **Transformer** architecture, originally proposed for neural machine translation in 2017 in *Attention is All You Need* paper.

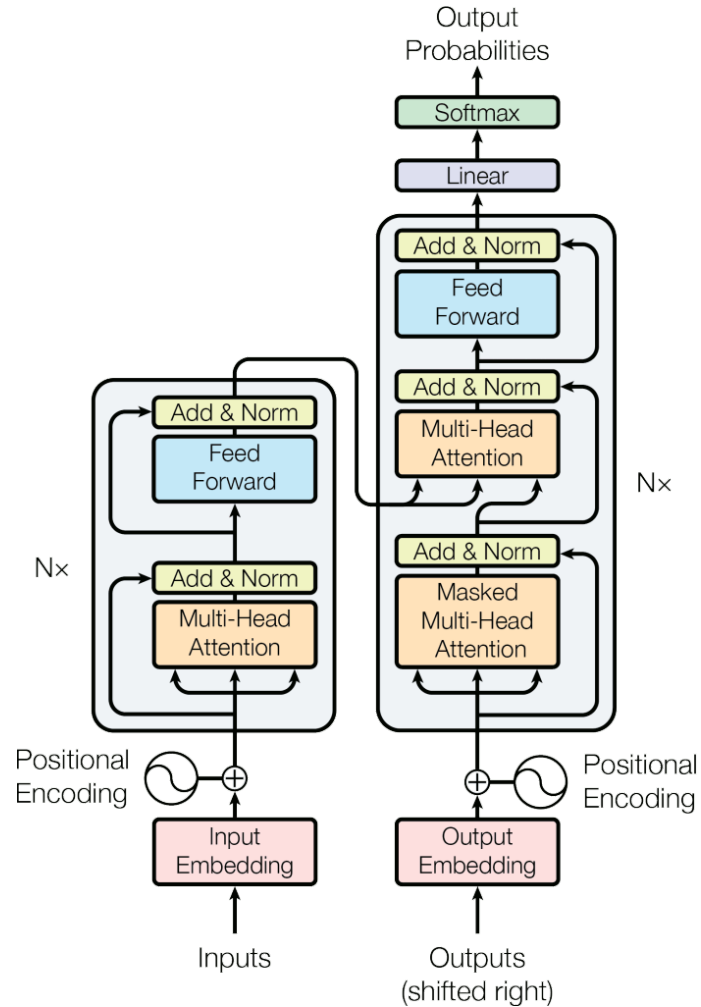
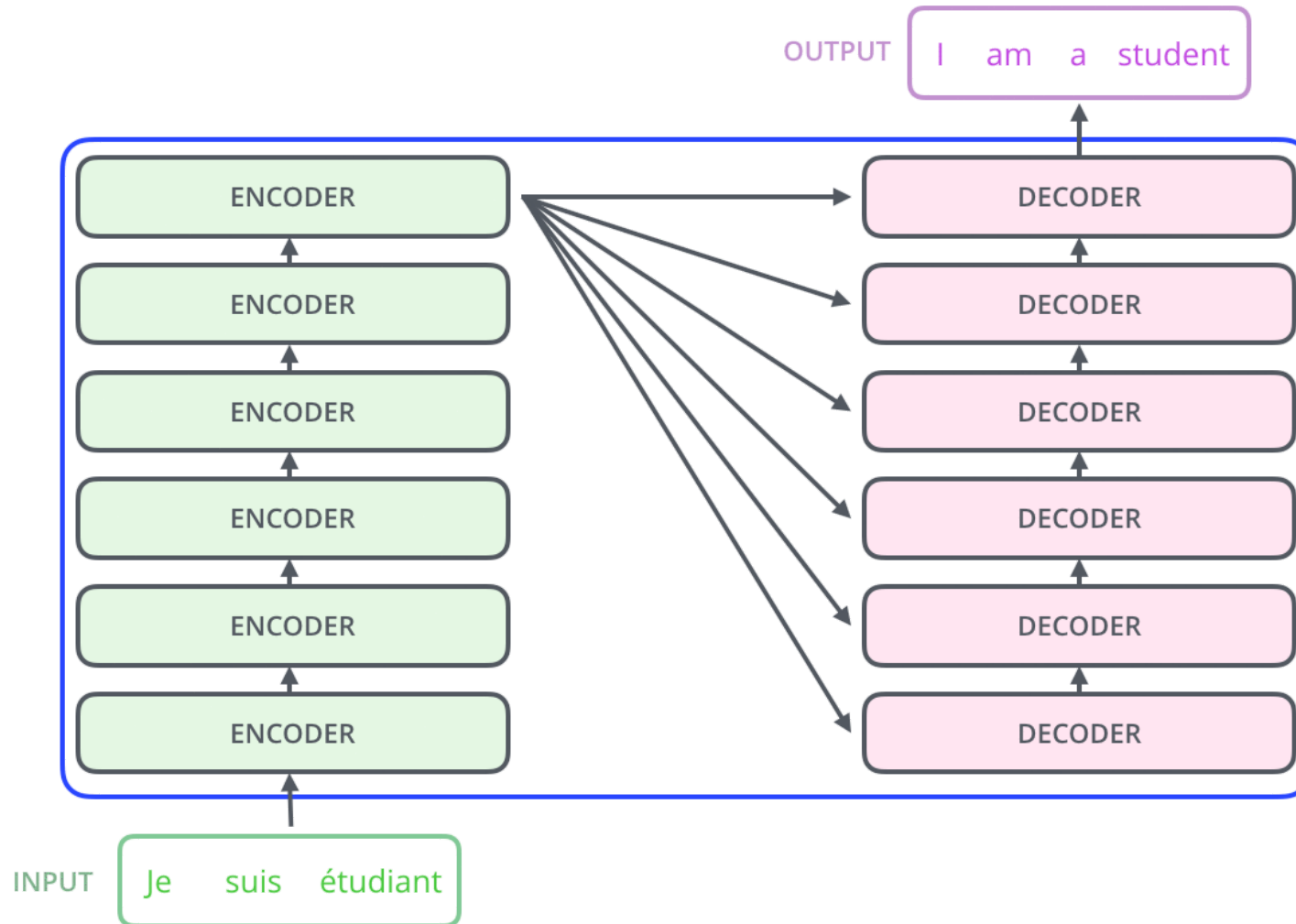
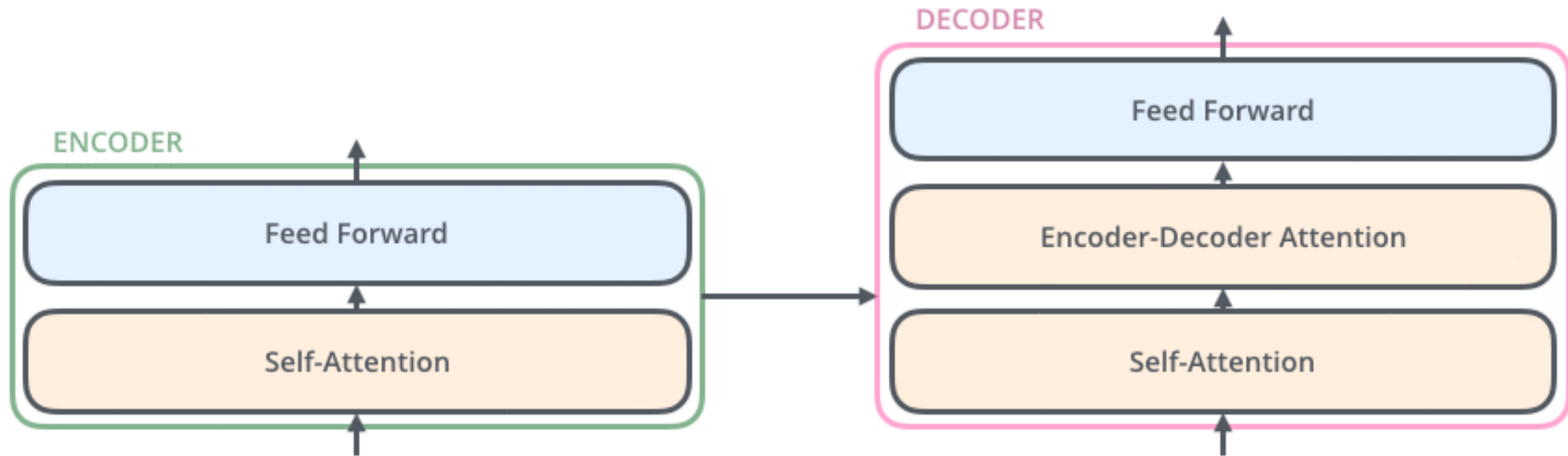

Figure 1 of "Attention Is All You Need", <https://arxiv.org/abs/1706.03762>



http://jalamar.github.io/images/t/The_transformer_encoder_decoder_stack.png



http://jalammar.github.io/images/t/Transformer_decoder.png

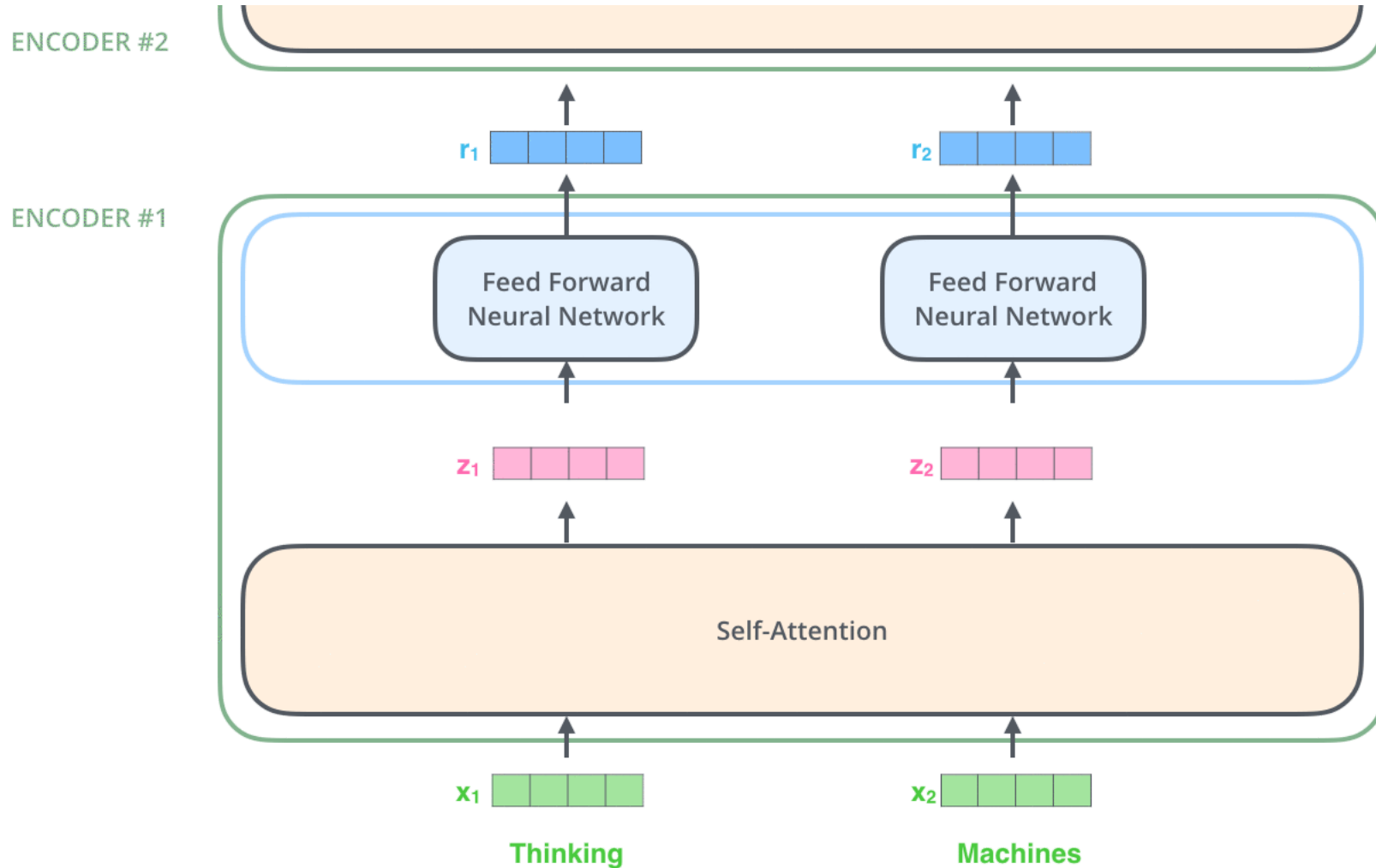

http://jalamar.github.io/images/t/encoder_with_tensors_2.png

Assume that we have a sequence of n words represented using a matrix $\mathbf{X} \in \mathbb{R}^{n \times d}$.

The attention module for a queries $\mathbf{Q} \in \mathbb{R}^{n \times d_k}$, keys $\mathbf{K} \in \mathbb{R}^{n \times d_k}$ and values $\mathbf{V} \in \mathbb{R}^{n \times d_v}$ is defined as:

$$\text{Attention}(\mathbf{Q}, \mathbf{K}, \mathbf{V}) = \text{softmax} \left(\frac{\mathbf{Q}\mathbf{K}^\top}{\sqrt{d_k}} \right) \mathbf{V}.$$

The queries, keys and values are computed from the input word representations \mathbf{X} using a linear transformation as

$$\mathbf{Q} = \mathbf{X}\mathbf{W}^Q$$

$$\mathbf{K} = \mathbf{X}\mathbf{W}^K$$

$$\mathbf{V} = \mathbf{X}\mathbf{W}^V$$

for trainable weight matrices $\mathbf{W}^Q, \mathbf{W}^K \in \mathbb{R}^{d \times d_k}$ and $\mathbf{W}^V \in \mathbb{R}^{d \times d_v}$.

Transformer – Self-Attention

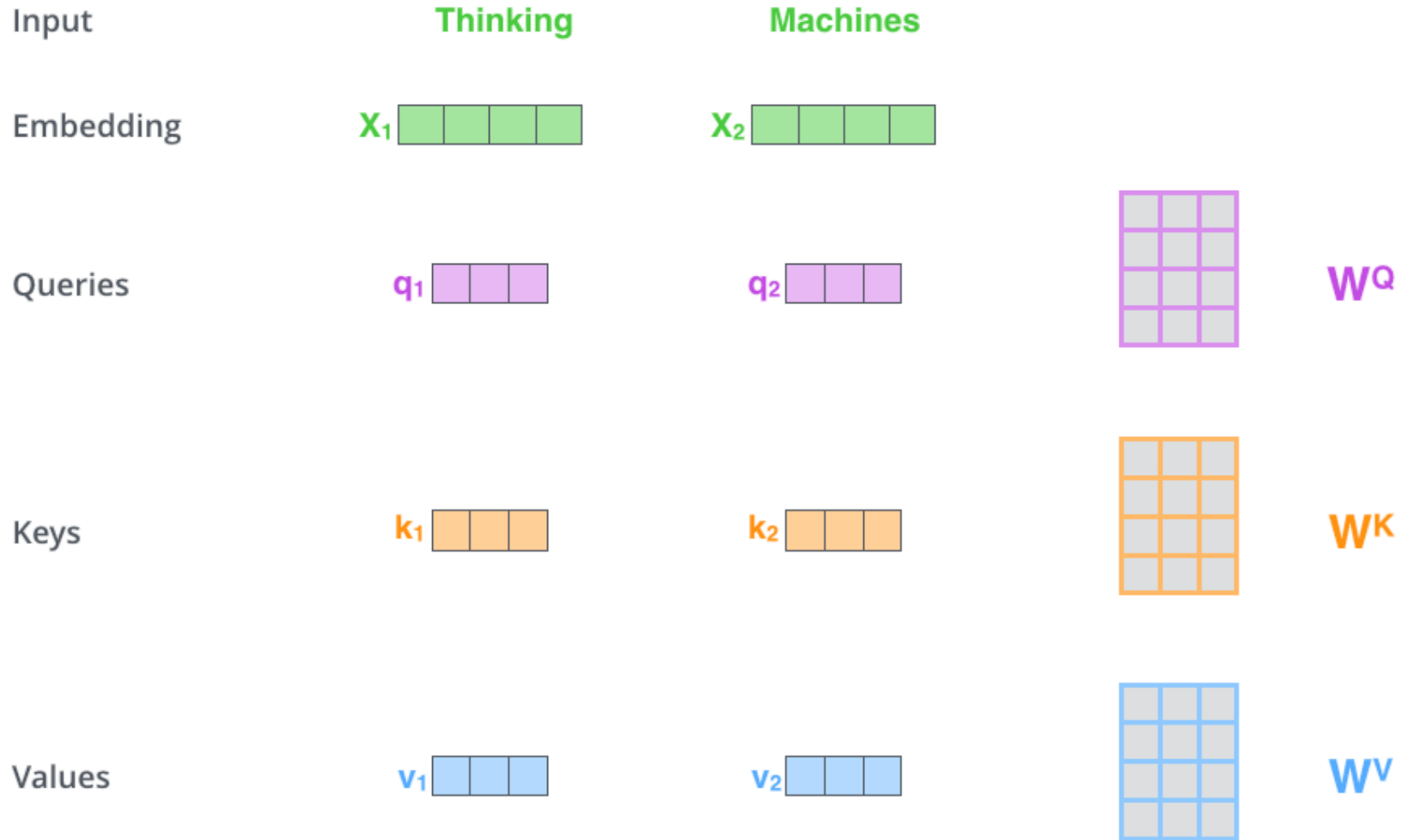

http://jalammar.github.io/images/t/transformer_self_attention_vectors.png

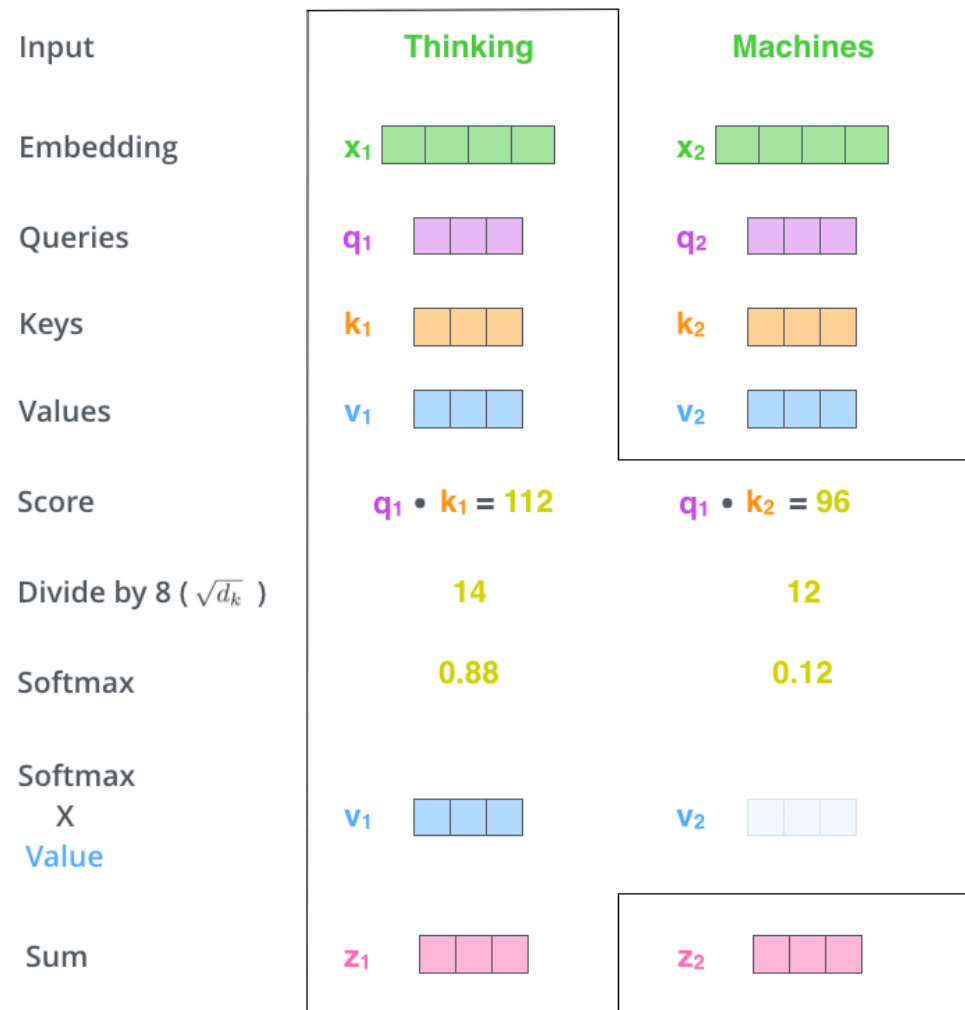

<http://jalamar.github.io/images/t/self-attention-output.png>

Transformer – Self-Attention

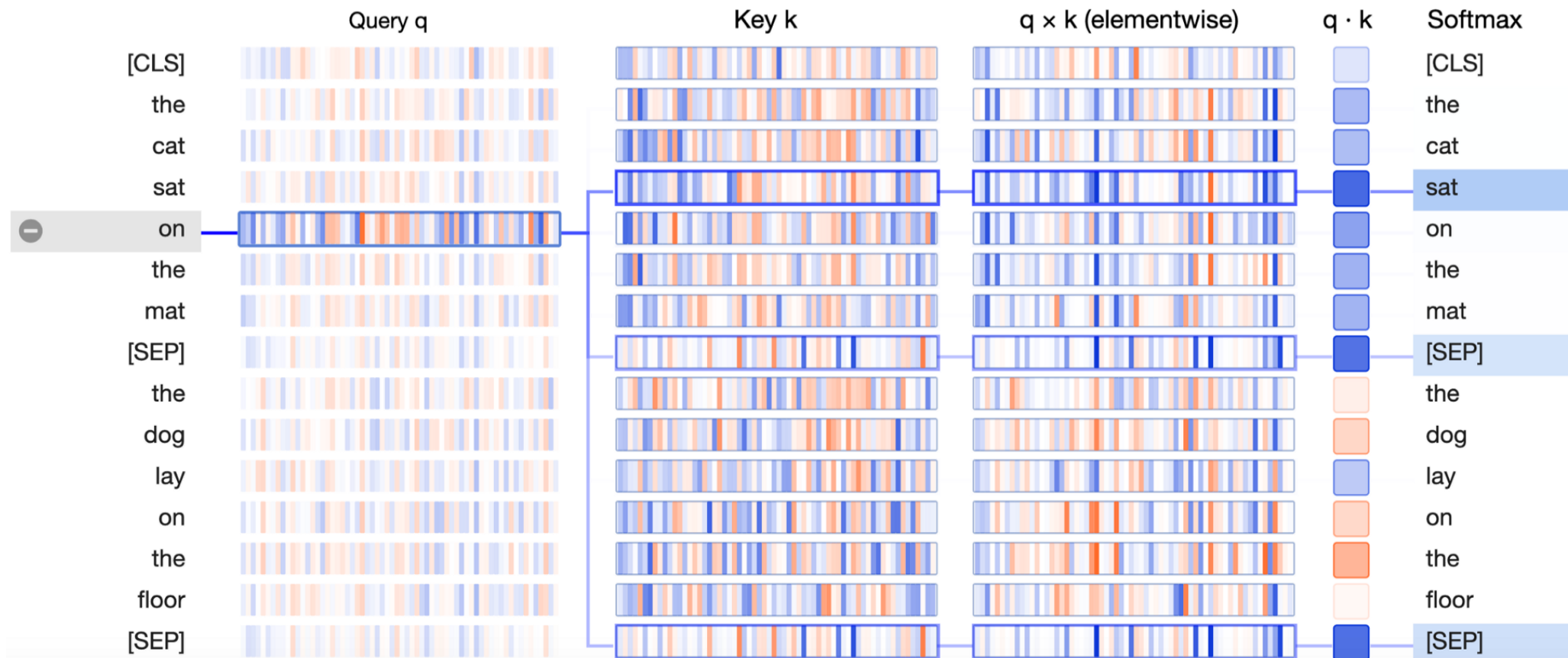

https://miro.medium.com/max/2000/1*jBsFVNOcJ-I3tsLVgni_w.png



$$\text{softmax} \left(\frac{\mathbf{Q} \times \mathbf{K}^T}{\sqrt{d_k}} \right) \mathbf{V}$$
$$= \mathbf{Z}$$

<http://jalammr.github.io/images/t/self-attention-matrix-calculation-2.png>

<http://jalammr.github.io/images/t/self-attention-matrix-calculation.png>

Multihead attention is used in practice. Instead of using one huge attention, we split queries, keys and values to several groups (similar to how ResNeXt works), compute the attention in each of the groups separately, concatenate the results and multiply them by a matrix \mathbf{W}^O .

Scaled Dot-Product Attention

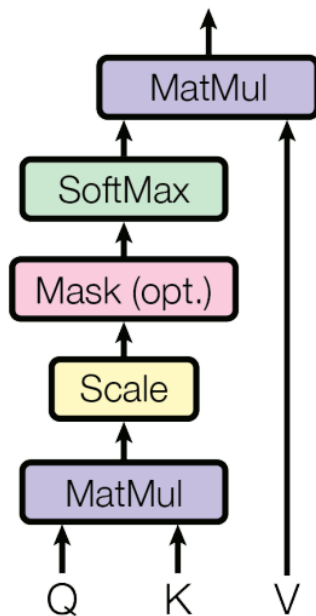

Multi-Head Attention

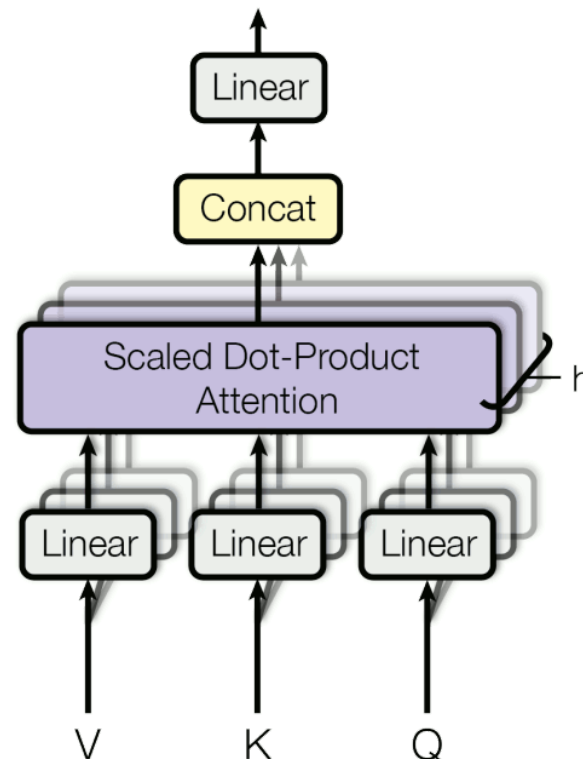
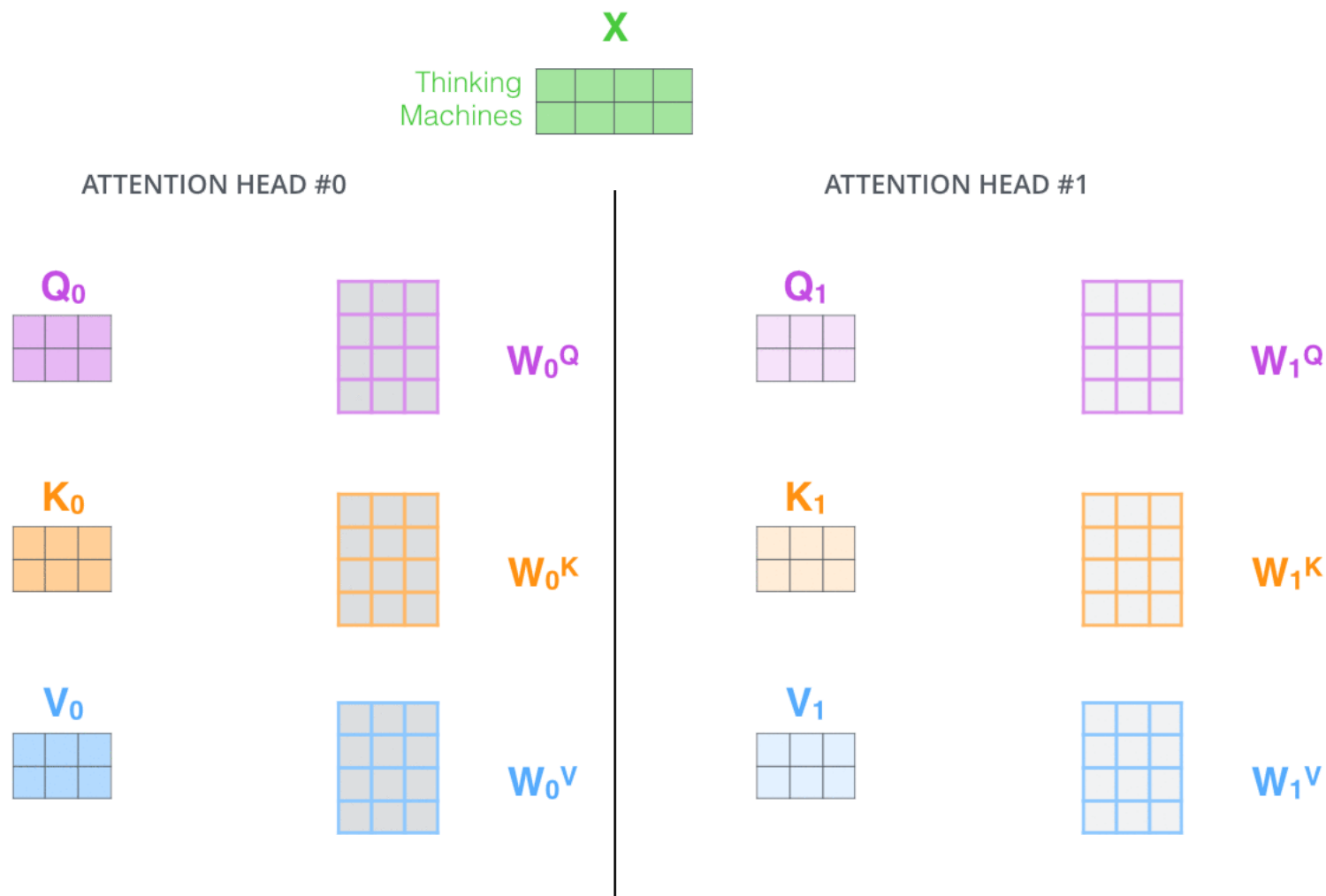
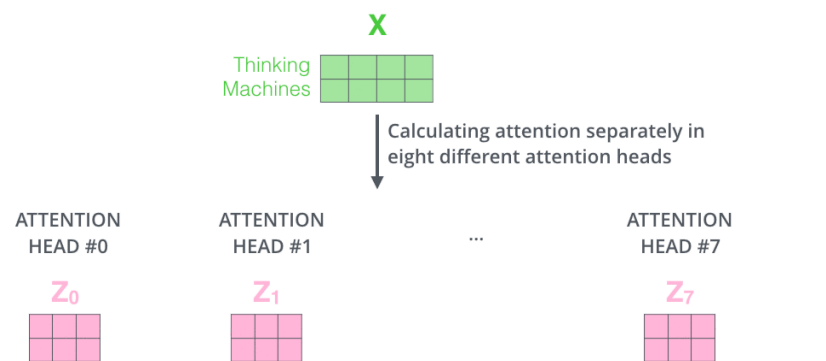

Figure 2 of "Attention Is All You Need", <https://arxiv.org/abs/1706.03762>

Transformer – Multihead Attention



http://jalammar.github.io/images/t/transformer_attention_heads_qkv.png



http://jalammr.github.io/images/t/transformer_attention_heads_z.png

1) Concatenate all the attention heads

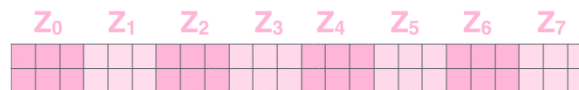

2) Multiply with a weight matrix W^O that was trained jointly with the model

X

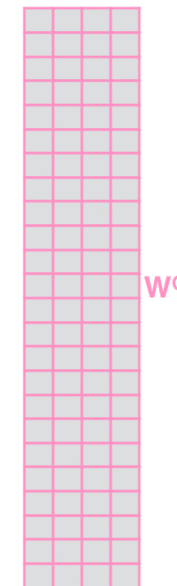

3) The result would be the Z matrix that captures information from all the attention heads. We can send this forward to the FFNN

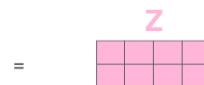

http://jalammr.github.io/images/t/transformer_attention_heads_weight_matrix_o.png

Transformer – Multihead Attention

1) This is our input sentence*

2) We embed each word*

3) Split into 8 heads. We multiply X or R with weight matrices

4) Calculate attention using the resulting $Q/K/V$ matrices

5) Concatenate the resulting Z matrices, then multiply with weight matrix W^O to produce the output of the layer

Thinking
Machines

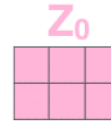
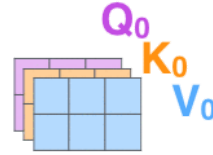
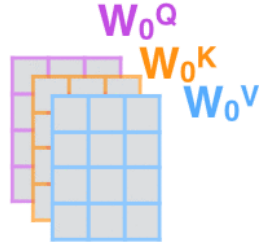
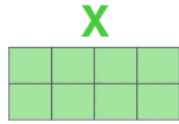

W^O

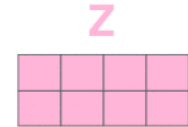

* In all encoders other than #0, we don't need embedding. We start directly with the output of the encoder right below this one

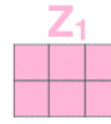
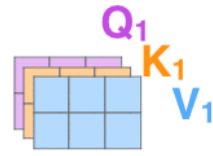
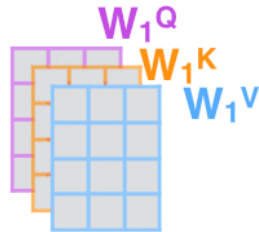

...

...

...

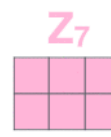
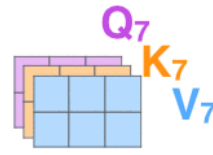
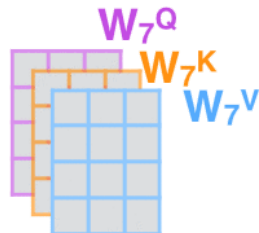

http://jalammar.github.io/images/t/transformer_multi-headed_self-attention-recap.png

Table 1: Maximum path lengths, per-layer complexity and minimum number of sequential operations for different layer types. n is the sequence length, d is the representation dimension, k is the kernel size of convolutions and r the size of the neighborhood in restricted self-attention.

Layer Type	Complexity per Layer	Sequential Operations	Maximum Path Length
Self-Attention	$O(n^2 \cdot d)$	$O(1)$	$O(1)$
Recurrent	$O(n \cdot d^2)$	$O(n)$	$O(n)$
Convolutional	$O(k \cdot n \cdot d^2)$	$O(1)$	$O(\log_k(n))$
Self-Attention (restricted)	$O(r \cdot n \cdot d)$	$O(1)$	$O(n/r)$

Table 1 of "Attention Is All You Need", <https://arxiv.org/abs/1706.03762>

Feed Forward Networks

The self-attention is complemented with FFN layers, which is a fully connected ReLU layer with four times as many hidden units as inputs, followed by another fully connected layer without activation.

Original “Post-LN” configuration

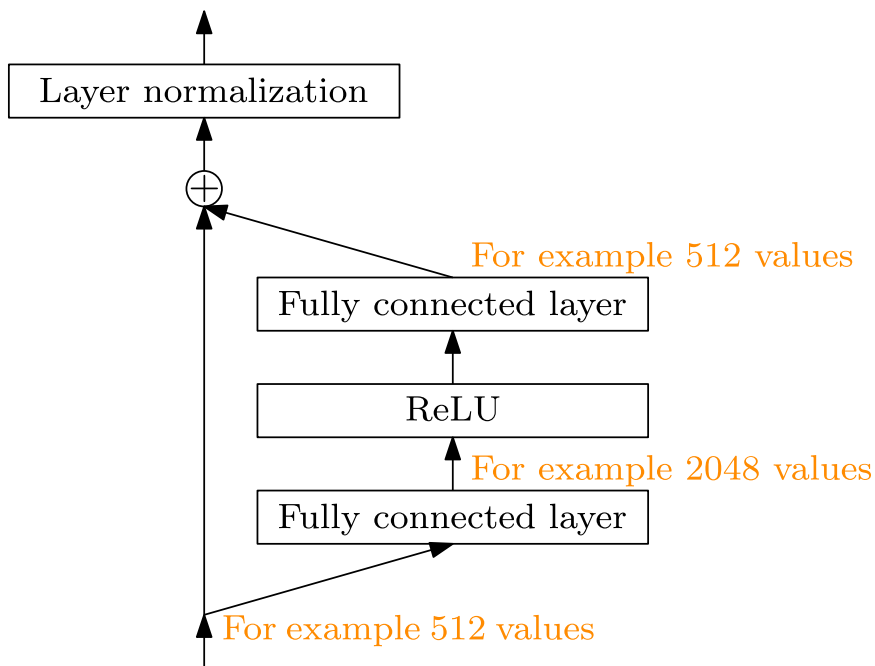

Improved “Pre-LN” configuration since 2020

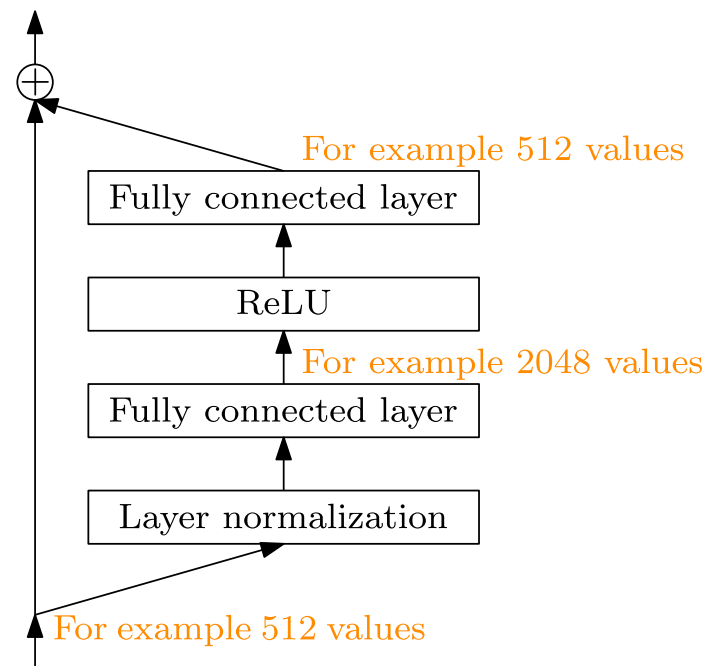

Transformer – Post-LN Configuration including Residuals

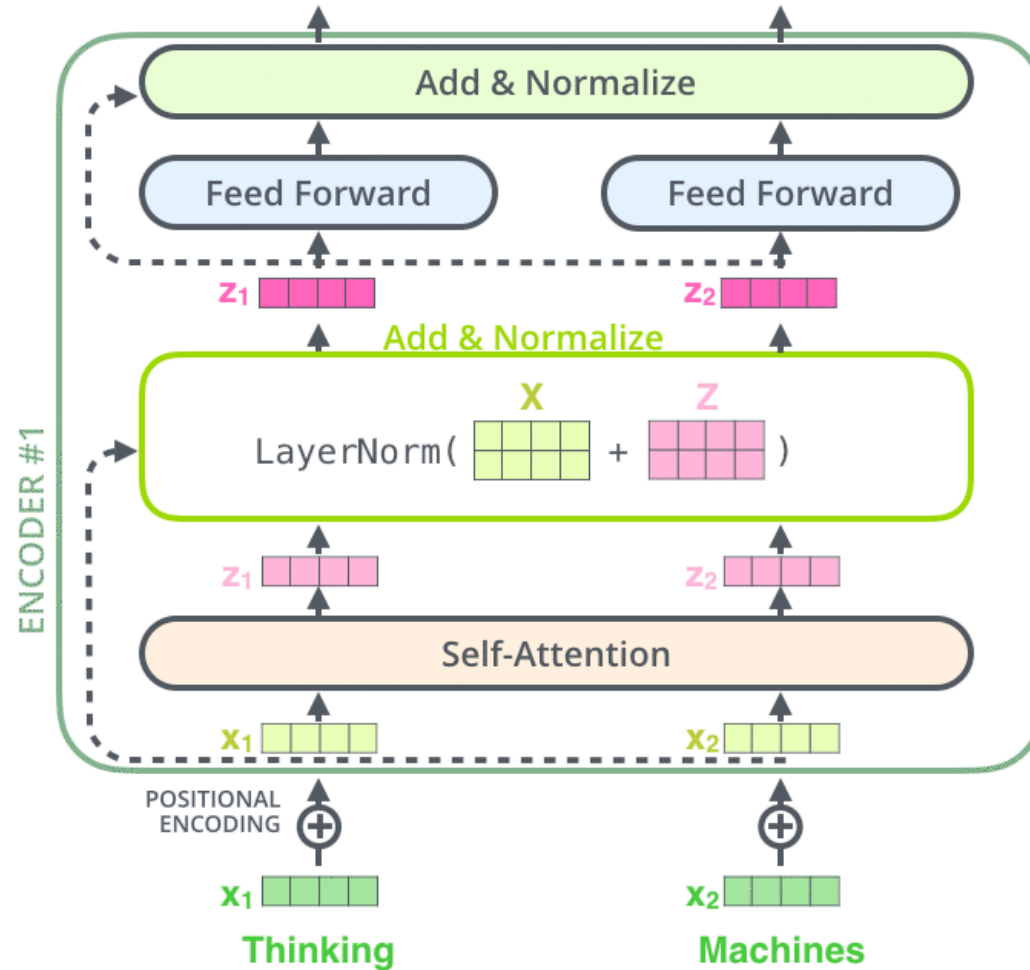

http://jalamar.github.io/images/t/transformer_resideual_layer_norm_2.png

Transformer – Pre-LN Configuration

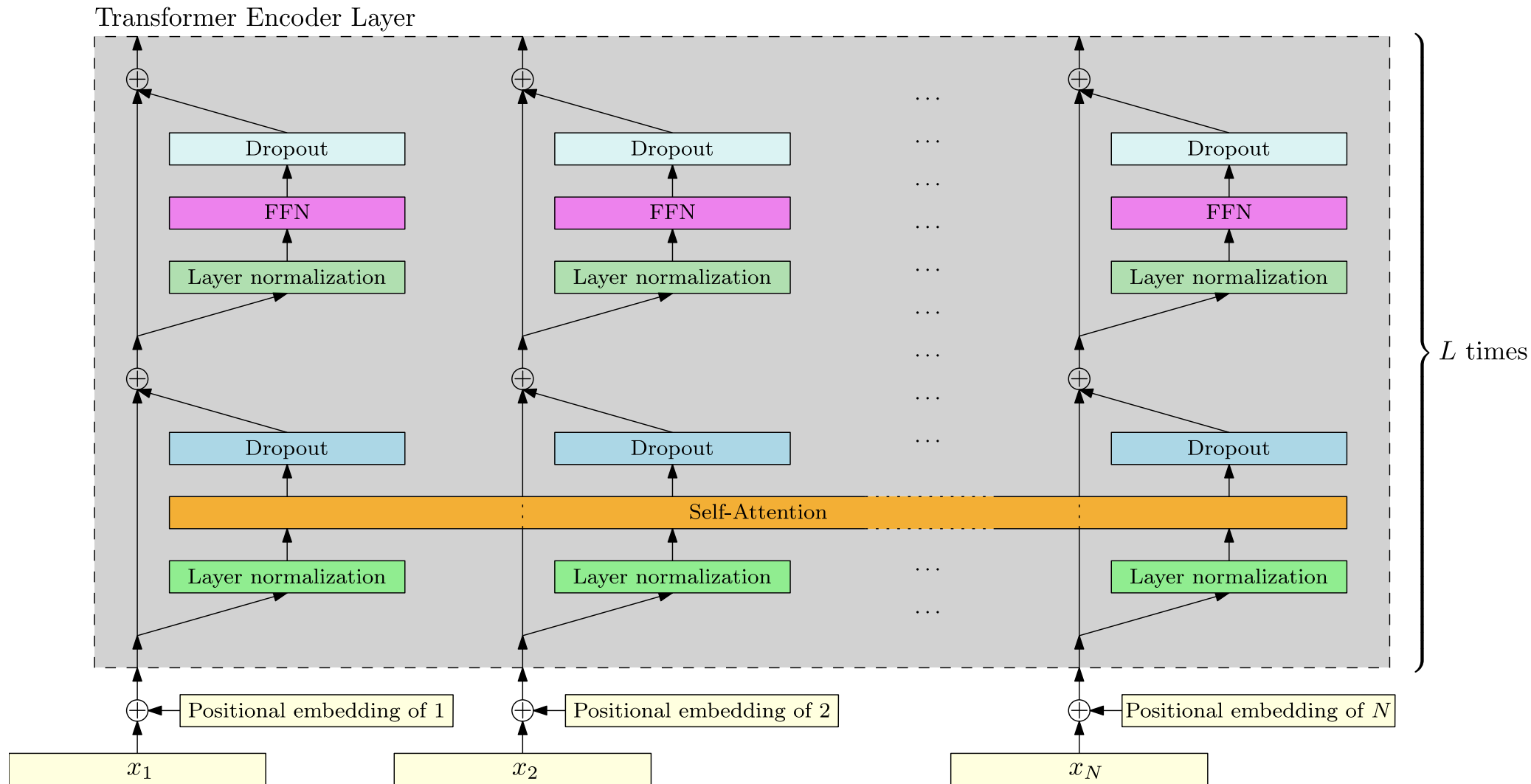

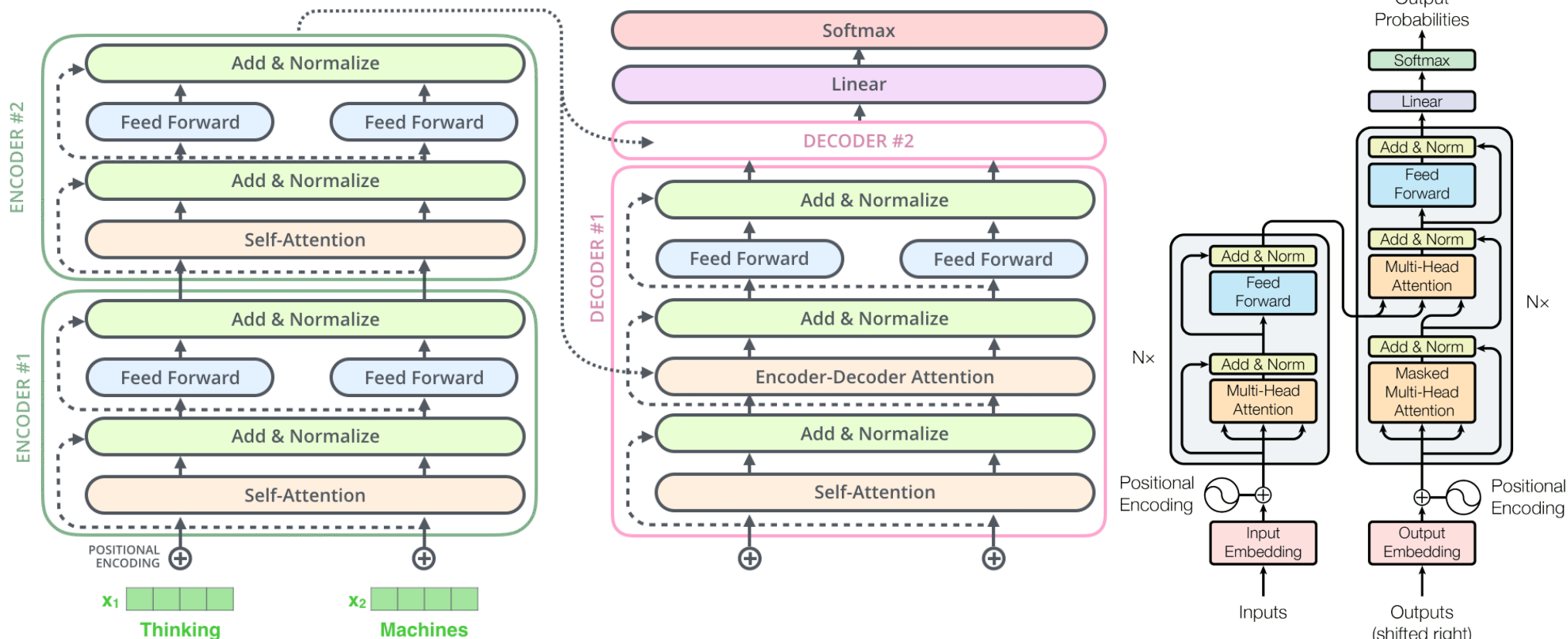

http://jalammar.github.io/images/t/transformer_residual_layer_norm_3.png

Figure 1 of "Attention Is All You Need", <https://arxiv.org/abs/1706.03762>

Masked Self-Attention

During decoding, the self-attention must attend only to earlier positions in the output sequence.

This is achieved by **masking** future positions, i.e., zeroing their weights out, which is usually implemented by setting them to $-\infty$ before the softmax calculation.

Encoder-Decoder Attention

In the encoder-decoder attentions, the *queries* comes from the decoder, while the *keys* and the *values* originate from the encoder.

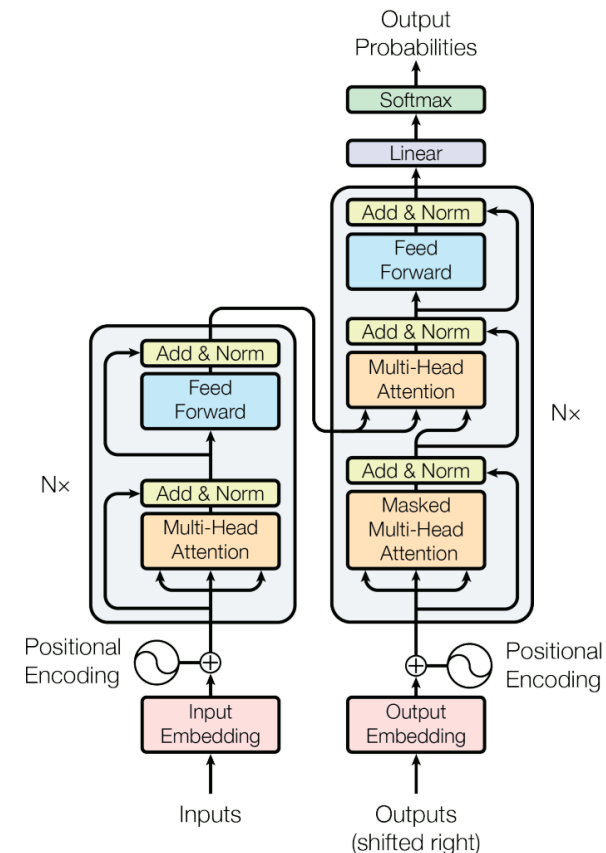
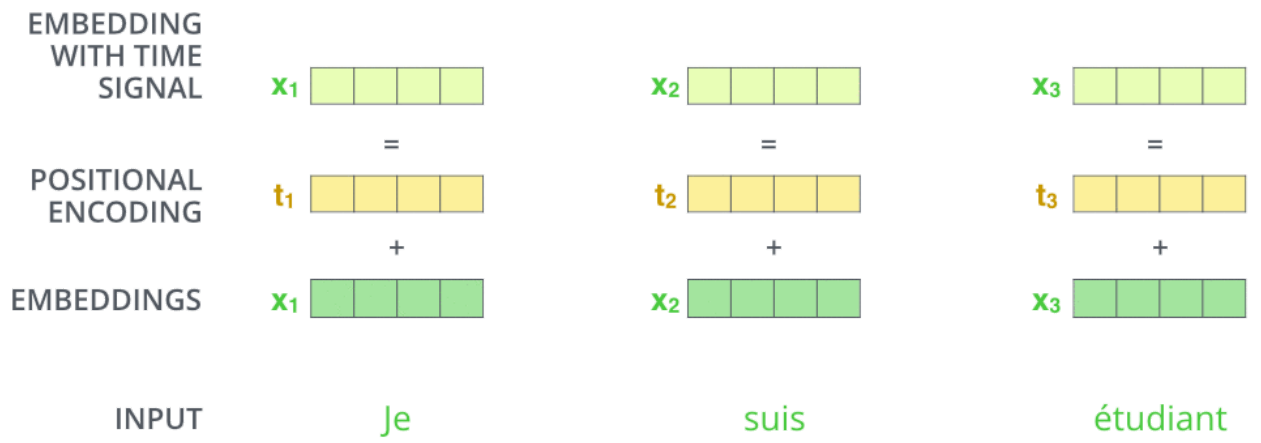
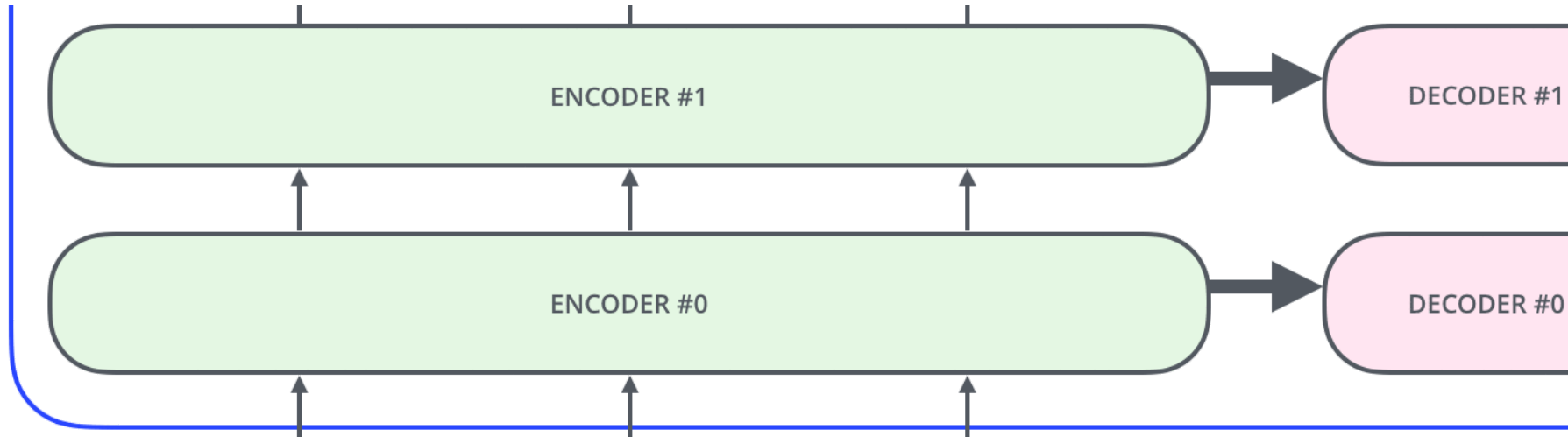

Figure 1 of "Attention Is All You Need", <https://arxiv.org/abs/1706.03762>

Transformer – Positional Embedding



http://jalamar.github.io/images/t/transformer_positional_encoding_vectors.png

Positional Embeddings

We need to encode positional information (which was implicit in RNNs).

- Learned embeddings for every position.
- Sinusoids of different frequencies:

$$\begin{aligned}\text{PE}_{(pos,2i)} &= \sin\left(pos/10000^{2i/d}\right) \\ \text{PE}_{(pos,2i+1)} &= \cos\left(pos/10000^{2i/d}\right)\end{aligned}$$

This choice of functions should allow the model to attend to relative positions, since for any fixed k , PE_{pos+k} is a linear function of PE_{pos} , because

$$\begin{aligned}\text{PE}_{(pos+k,2i)} &= \sin\left((pos+k)/10000^{2i/d}\right) \\ &= \sin\left(pos/10000^{2i/d}\right) \cdot \cos\left(k/10000^{2i/d}\right) + \cos\left(pos/10000^{2i/d}\right) \cdot \sin\left(k/10000^{2i/d}\right) \\ &= \textit{offset}_{(k,2i)} \cdot \text{PE}_{(pos,2i)} + \textit{offset}_{(k,2i+1)} \cdot \text{PE}_{(pos,2i+1)}.\end{aligned}$$

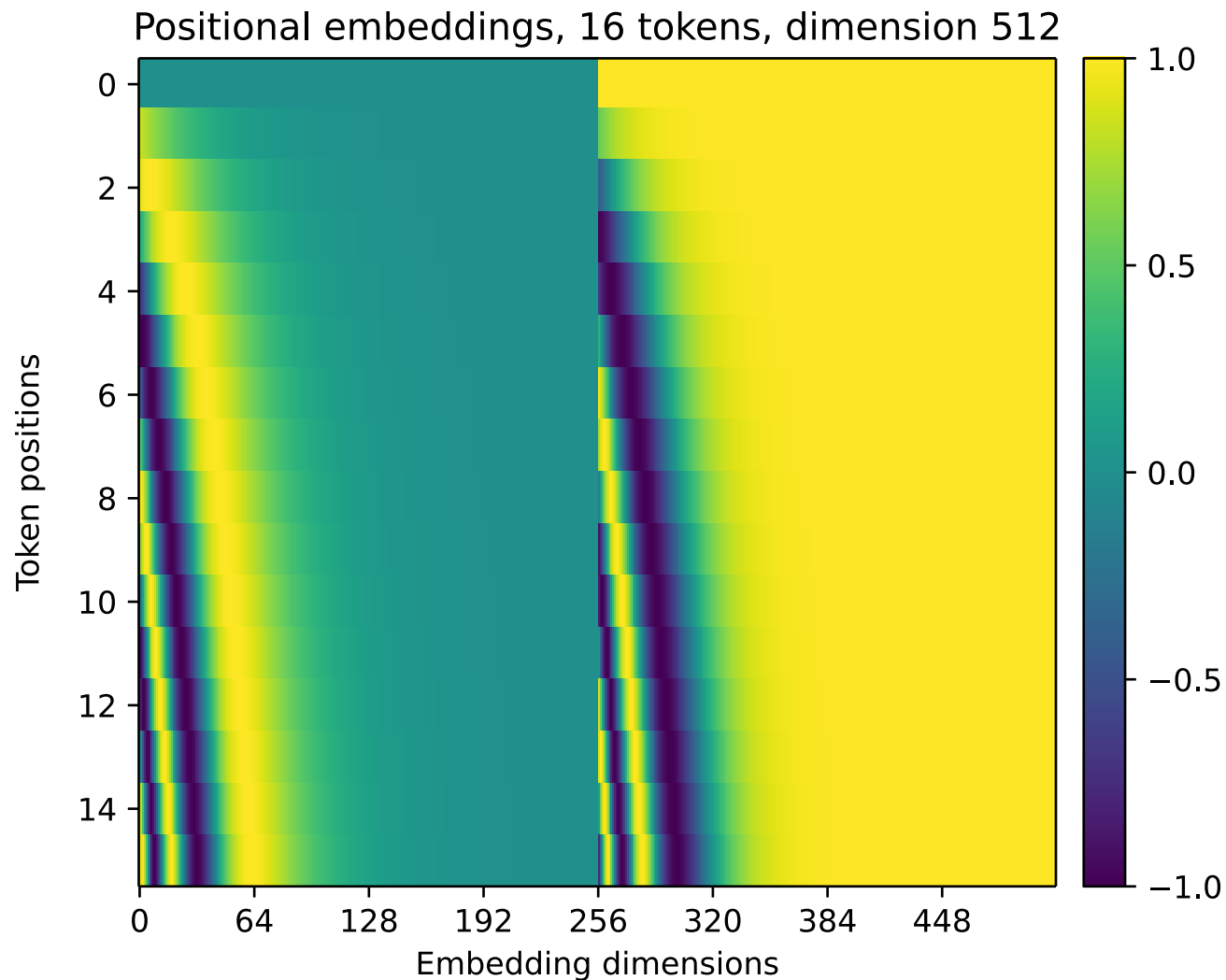

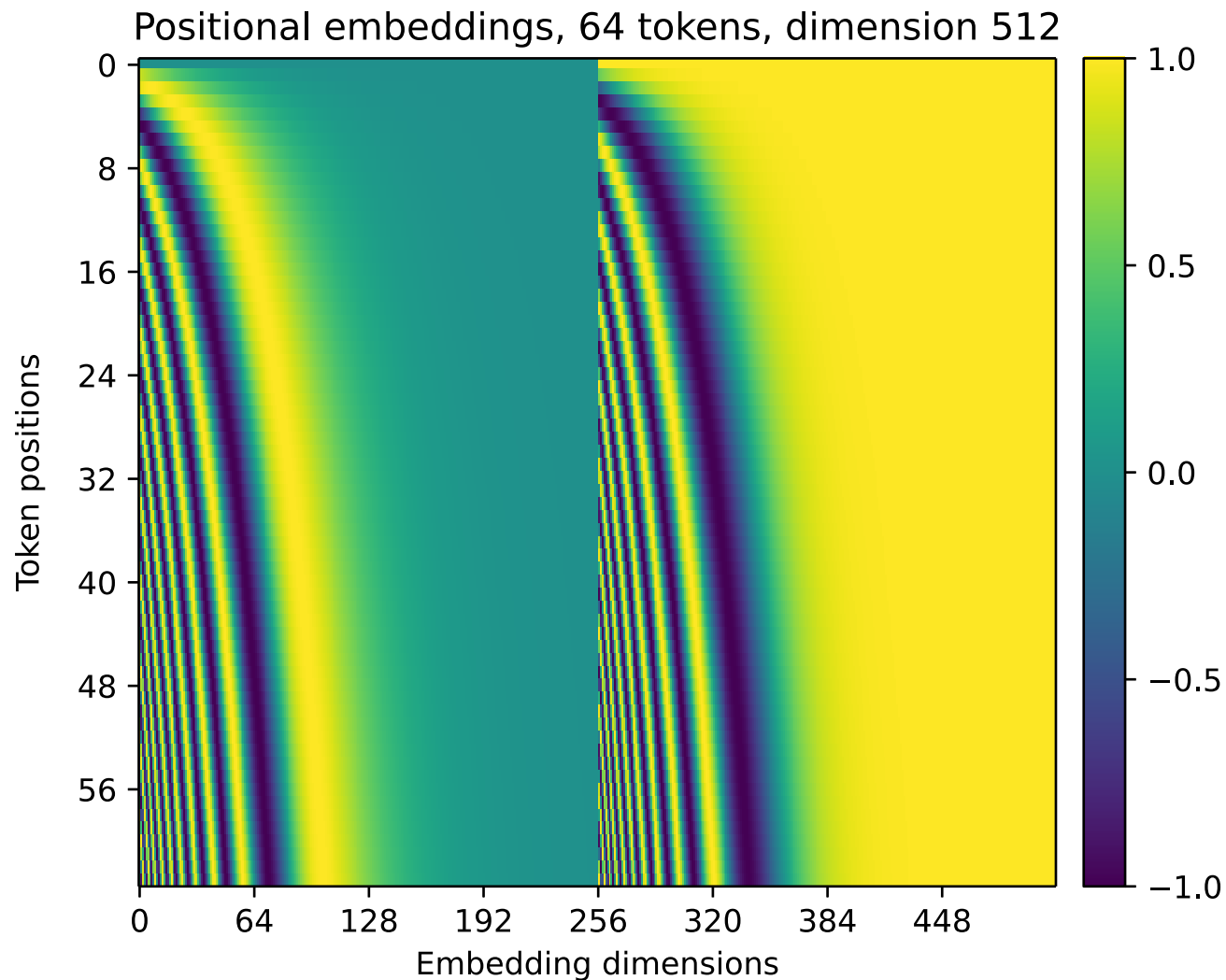

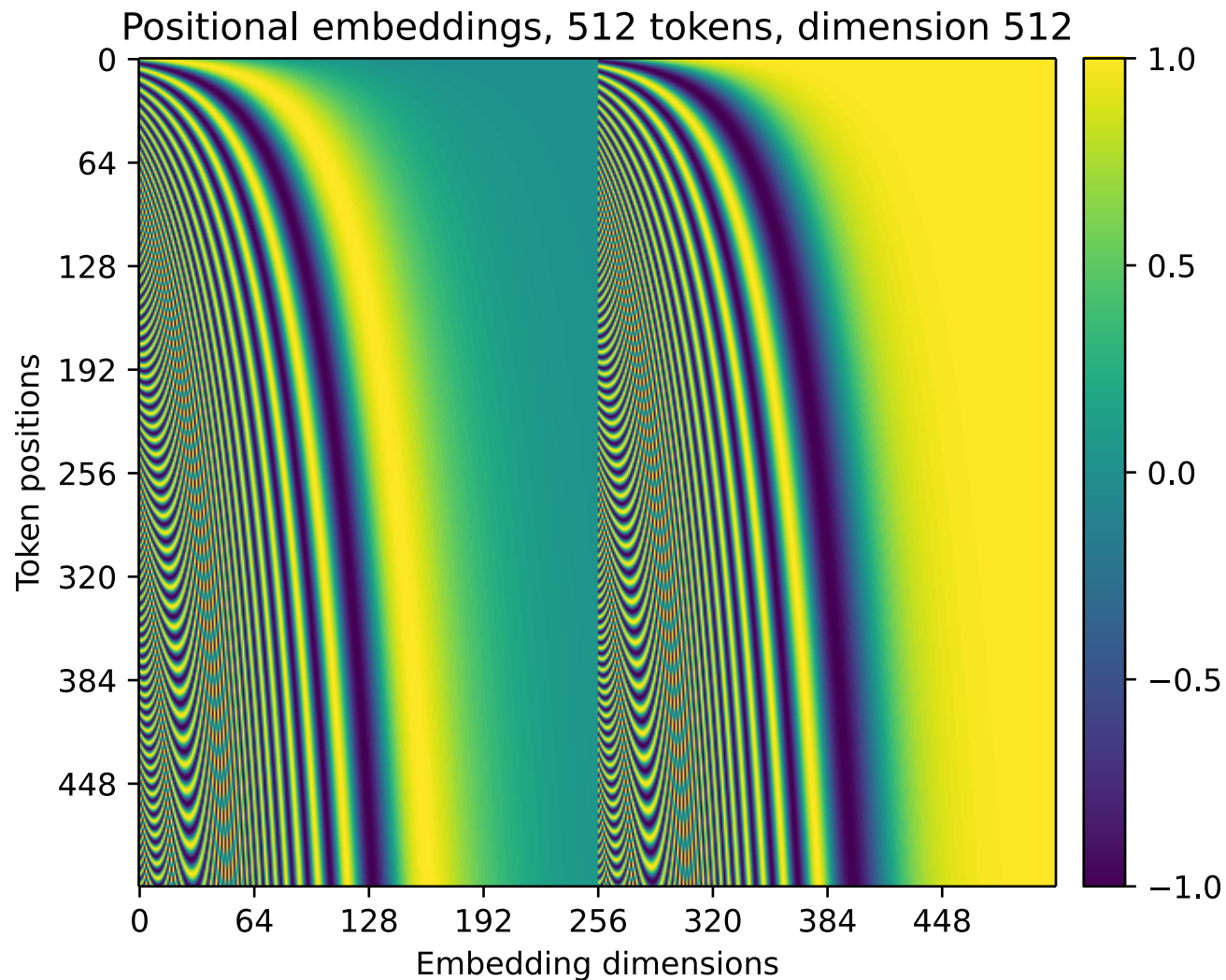

Regularization

The network is regularized by:

- dropout of input embeddings,
- dropout of each sub-layer, just before it is added to the residual connection (and then normalized),
- label smoothing.

Default dropout rate and also label smoothing weight is 0.1.

Parallel Execution

Because of the *masked attention*, training can be performed in parallel.

However, inference is still sequential.

Optimizer

Adam optimizer (with $\beta_2 = 0.98$, smaller than the default value of 0.999) is used during training, with the learning rate decreasing proportionally to inverse square root of the step number.

Warmup

Furthermore, during the first *warmup_steps* updates, the learning rate is increased linearly from zero to its target value.

$$learning_rate = \frac{1}{\sqrt{d_{\text{model}}}} \min \left(\frac{1}{\sqrt{step_num}}, \frac{step_num}{warmup_steps} \cdot \frac{1}{\sqrt{warmup_steps}} \right).$$

In the original paper, 4000 warmup steps were proposed.

Table 2: The Transformer achieves better BLEU scores than previous state-of-the-art models on the English-to-German and English-to-French newstest2014 tests at a fraction of the training cost.

Model	BLEU		Training Cost (FLOPs)	
	EN-DE	EN-FR	EN-DE	EN-FR
ByteNet [18]	23.75			
Deep-Att + PosUnk [39]		39.2		$1.0 \cdot 10^{20}$
GNMT + RL [38]	24.6	39.92	$2.3 \cdot 10^{19}$	$1.4 \cdot 10^{20}$
ConvS2S [9]	25.16	40.46	$9.6 \cdot 10^{18}$	$1.5 \cdot 10^{20}$
MoE [32]	26.03	40.56	$2.0 \cdot 10^{19}$	$1.2 \cdot 10^{20}$
Deep-Att + PosUnk Ensemble [39]		40.4		$8.0 \cdot 10^{20}$
GNMT + RL Ensemble [38]	26.30	41.16	$1.8 \cdot 10^{20}$	$1.1 \cdot 10^{21}$
ConvS2S Ensemble [9]	26.36	41.29	$7.7 \cdot 10^{19}$	$1.2 \cdot 10^{21}$
Transformer (base model)	27.3	38.1	$3.3 \cdot 10^{18}$	
Transformer (big)	28.4	41.8	$2.3 \cdot 10^{19}$	

Table 2 of "Attention Is All You Need", <https://arxiv.org/abs/1706.03762>

	N	d_{model}	d_{ff}	h	d_k	d_v	P_{drop}	ϵ_{ls}	train steps	PPL (dev)	BLEU (dev)	params $\times 10^6$	
base	6	512	2048	8	64	64	0.1	0.1	100K	4.92	25.8	65	
(A)				1	512	512				5.29	24.9		
				4	128	128				5.00	25.5		
				16	32	32				4.91	25.8		
				32	16	16				5.01	25.4		
(B)					16					5.16	25.1	58	
					32					5.01	25.4	60	
(C)	2									6.11	23.7	36	
	4									5.19	25.3	50	
	8									4.88	25.5	80	
		256			32	32				5.75	24.5	28	
		1024			128	128				4.66	26.0	168	
			1024							5.12	25.4	53	
			4096						4.75	26.2	90		
(D)							0.0			5.77	24.6		
							0.2			4.95	25.5		
								0.0		4.67	25.3		
								0.2		5.47	25.7		
(E)									positional embedding instead of sinusoids			4.92	25.7
big	6	1024	4096	16			0.3		300K	4.33	26.4	213	

Table 4 of "Attention Is All You Need", <https://arxiv.org/abs/1706.03762>

Main Takeaway

Generally, Transformer provides more powerful sequence-to-sequence architecture and also sequence element representation architecture than RNNs, but usually requires substantially more data.

At the end of 2017, a new type of *deep contextualized* word representations was proposed by Peters et al., called ELMo, **E**mbdings from **L**anguage **M**odels.

The ELMo embeddings were based on a two-layer pre-trained LSTM language model, where a language model predicts following word based on a sentence prefix. Specifically, two such models were used, one for the forward direction and the other one for the backward direction.

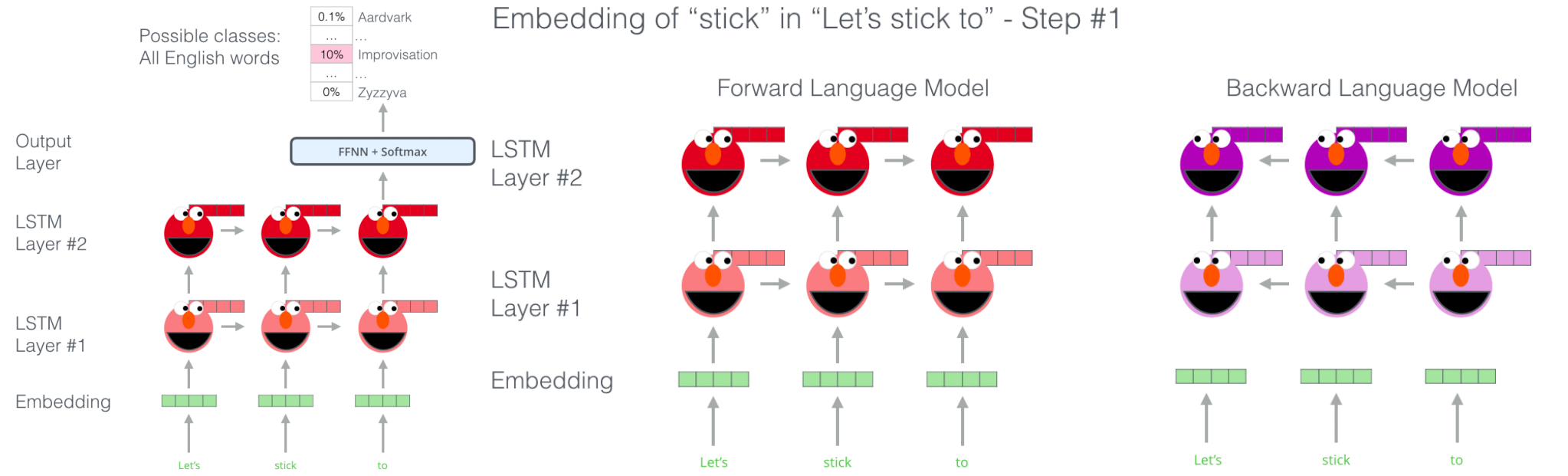

<http://jalamar.github.io/images/Bert-language-modeling.png>

<http://jalamar.github.io/images/elmo-forward-backward-language-model-embedding.png>

To compute an embedding of a word in a sentence, the concatenation of the two language model's hidden states is used.

Embedding of "stick" in "Let's stick to" - Step #2

1- Concatenate hidden layers



2- Multiply each vector by a weight based on the task

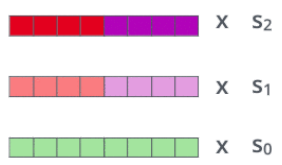

3- Sum the (now weighted) vectors



ELMo embedding of "stick" for this task in this context

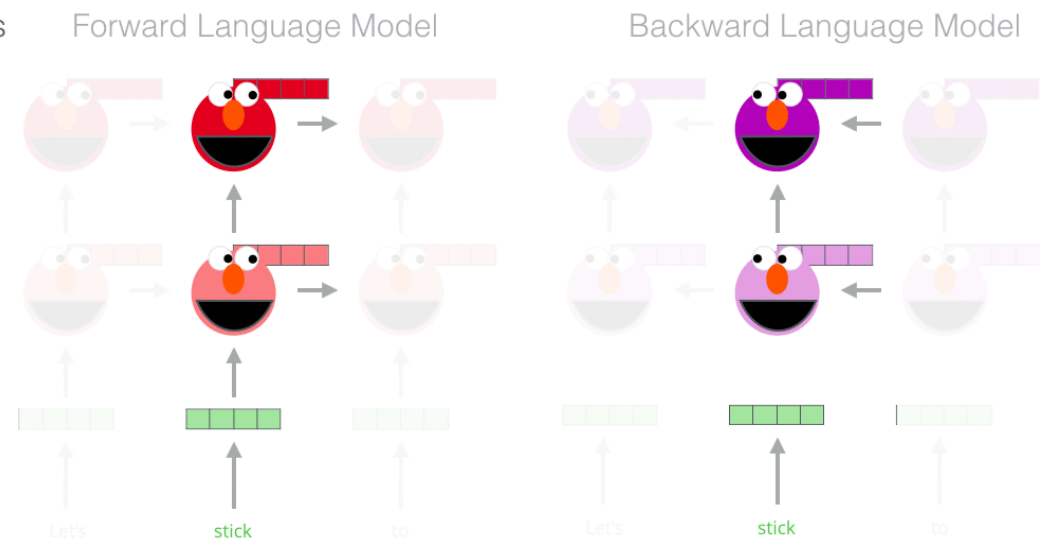

<http://jalammar.github.io/images/elmo-embedding.png>

Pre-trained ELMo embeddings substantially improved several NLP tasks.

A year later after ELMo, at the end of 2018, a new model called BERT (standing for **B**idirectional **E**ncoder **R**epresentations from **T**ransformers) was proposed. It is nowadays one of the most dominating approaches for pre-training word embeddings and for paragraph representation.



https://www.sesameworkshop.org/sites/default/files/imageservicecache/2019-03/header5120x1620_50thanniversary.png/4b00e17bb509f5c630c57c318b37d0da.webp

In the BERT model computes contextualized representations using a bidirectional Transformer architecture.

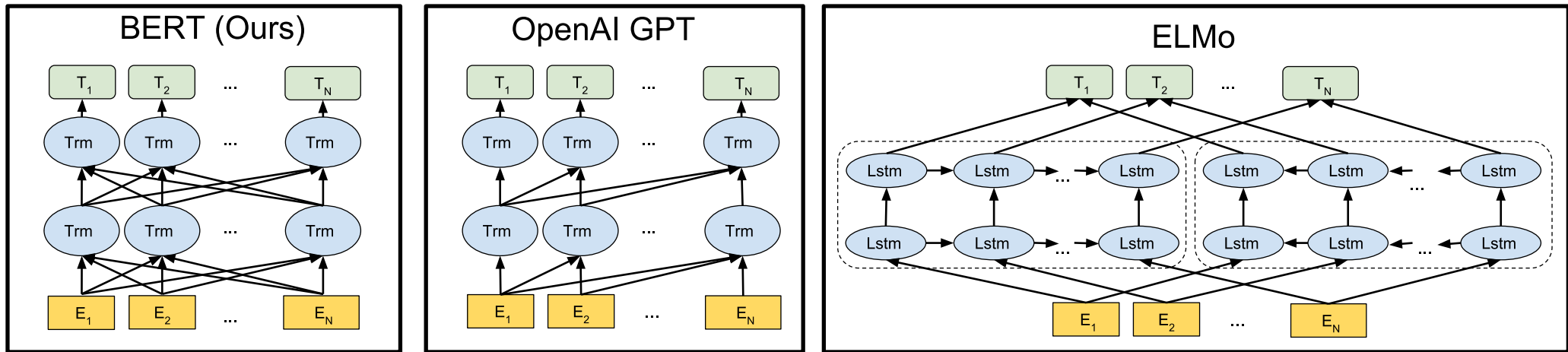
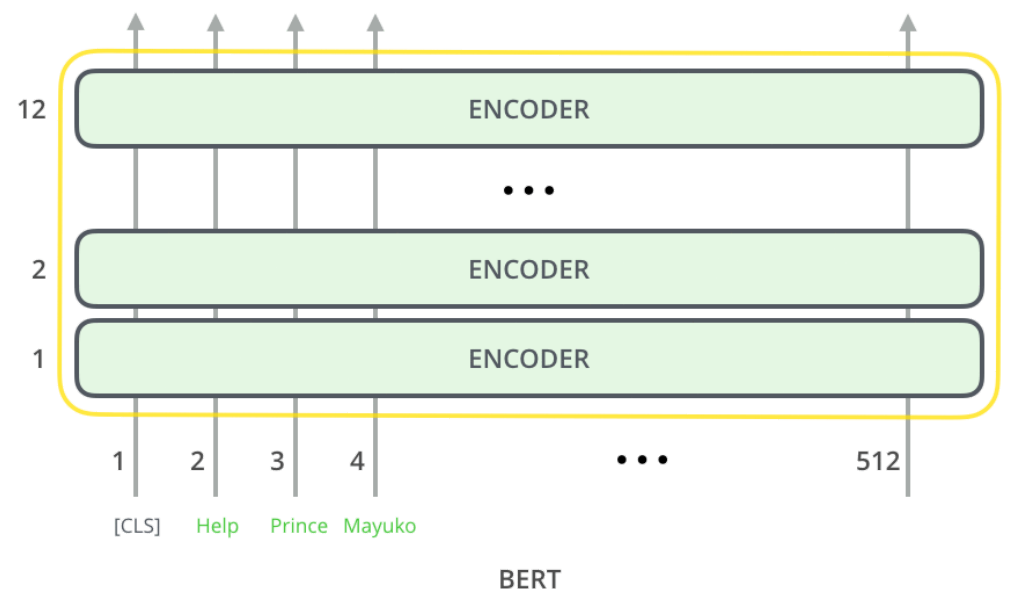

Figure 3 of "BERT: Pre-training of Deep Bidirectional Transformers for Language Understanding", <https://arxiv.org/abs/1810.04805>

The baseline BERT base model consists of 12 Transformer layers:



<http://jalamar.github.io/images/bert-encoders-input.png>

The bidirectionality is important, but it makes training difficult.

BERT Input

The input for the BERT model is a sequence of subwords, namely their identifiers. This input represents two so-called *sentences*, but they are in fact pieces of text with hundreds of subwords (512 maximum in total). The first token is a special CLS token and every sentence is ended by a SEP token.

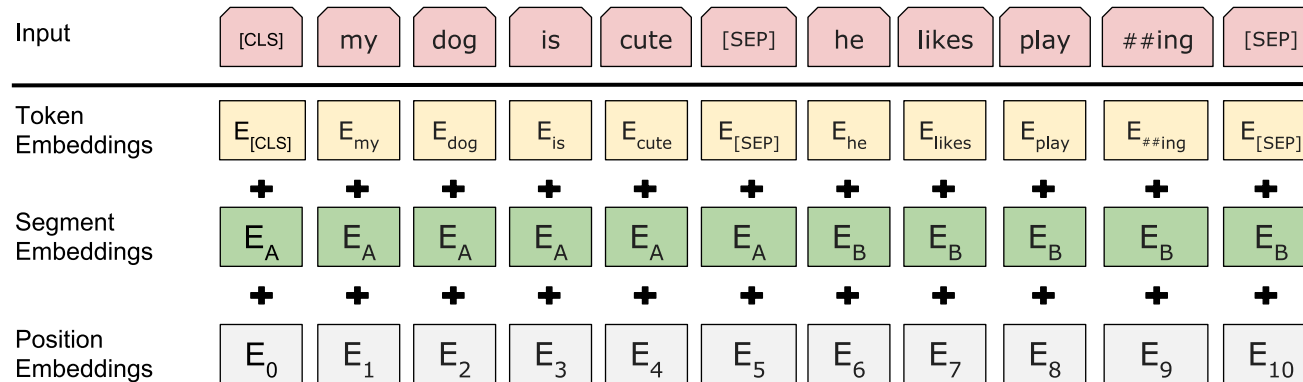

Figure 2 of "BERT: Pre-training of Deep Bidirectional Transformers for Language Understanding", <https://arxiv.org/abs/1810.04805>

Every subword representation is a sum of:

- trainable subword embeddings,
- trainable positional embeddings (not the sinusoidal embeddings, but I do not know why),
- trainable segment embeddings, which indicate if a token belongs to a sentence A (inclusively up to its SEP token) or to sentence B.

BERT Pretraining

The BERT model is pretrained using two objectives:

- masked language model** – 15% of the input words are **masked**, and the model tries to predict them (using a head consisting of a fully connected layer with softmax activation);
 - 80% of them are replaced by a special MASK token;
 - 10% of them are replaced by a random word;
 - 10% of them are left intact.
- next sentence prediction** – the model tries to predict whether the second *sentence* followed the first one in the raw corpus (using a head that on top of the CLS output adds a fully connected layer with tanh activation (*pooler*), followed by a softmax-activated fully connected layer with two outputs).
 - 50% of the time the second sentence is the actual next sentence;
 - 50% of the time the second sentence is a random sentence from the corpus.

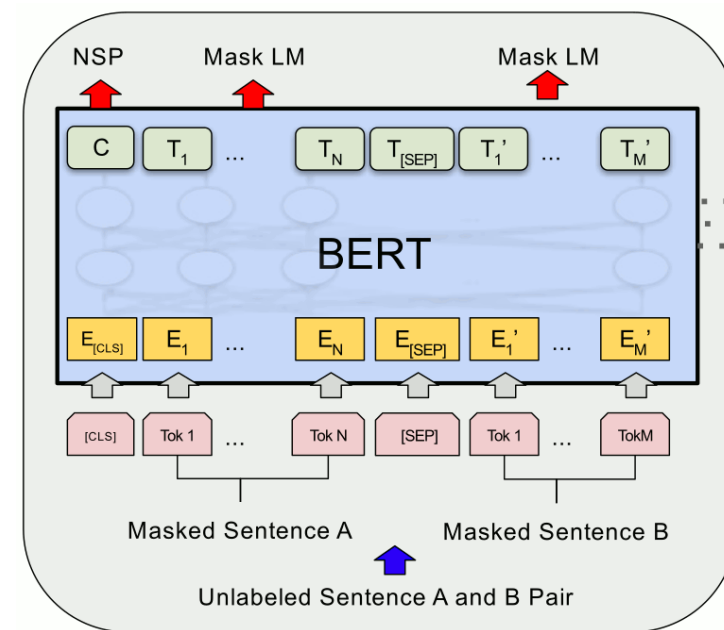

Pre-training

Figure 1 of "BERT: Pre-training of Deep Bidirectional Transformers for Language Understanding", <https://arxiv.org/abs/1810.04805>

BERT Pretraining

For pre-training, English BookCorpus (800M words) and Wikipedia (2,500M words) are used, with a 30k WordPieces vocabulary.

Batch size is 256 sequences, each 512 subwords, giving 128k tokens per batch. Adam with learning rate $1e-4$ is used, with linear learning rate warmup for the first 10k steps, followed by a linear learning rate decay to 0. Standard momentum parameters are used, and L^2 weight decay of 0.01 is utilized.

Dropout of 0.1 on all layers is used, and GELU activation is used instead of ReLU.

Furthermore, because longer sequences are quadratically more expensive, first 90% of the pre-training is performed on sequences of length 128, and only the last 10% use sequences of length 512.

Two variants are considered:

- BERT *base* with 12 layers, 12 attention heads and hidden size 768 (110M parameters),
- BERT *large* with 24 layers, 16 attention heads and hidden size 1024 (340M parameters).

ReLU multiplies the input by zero or one, depending on its value.

Dropout stochastically multiplies the input by zero or one.

Both these functionalities are merged in Gaussian error linear units (GELUs), where the input value is multiplied by $m \sim \text{Bernoulli}(\Phi(x))$, where $\Phi(x) = P(x' \leq x)$ for $x' \sim \mathcal{N}(0, 1)$ is the cumulative density function of the standard normal distribution.

The GELUs compute the expectation of this value, i.e.,

$$\text{GELU}(x) = x \cdot \Phi(x) + 0 \cdot (1 - \Phi(x)) = x\Phi(x).$$

GELUs can be approximated using (no need to remember this):

$$0.5x \left(1 + \tanh \left[\sqrt{2/\pi}(x + 0.044715x^3) \right] \right) \quad \text{or} \quad x\sigma(1.702x).$$

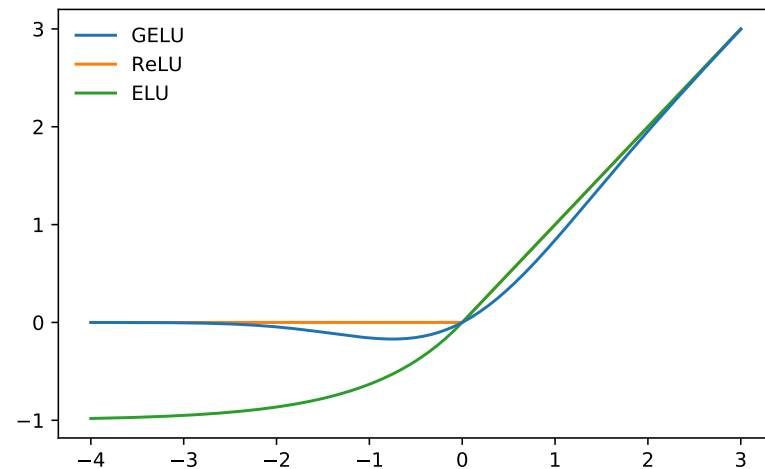

Figure 1: The GELU ($\mu = 0, \sigma = 1$), ReLU, and ELU ($\alpha = 1$).

Figure 1 of "Gaussian Error Linear Units (GELUs)",
<https://arxiv.org/abs/1606.08415>

BERT – Finetuning

The pre-trained BERT model can be finetuned on a range of tasks:

- **sentence element representation**

- PoS tagging
- named entity recognition
- ...

- **sentence representation**

- text classification

- **sentence relation representation**

- textual entailment, aka natural language inference (the second sentence is *implied by/contradicts/has no relation to* the first sentence)
- textual similarity
- paraphrase detection
- natural language inference

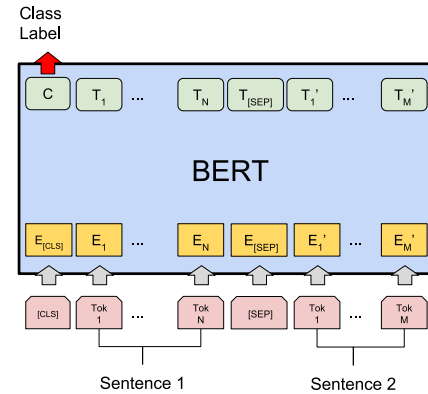

(a) Sentence Pair Classification Tasks: MNL, QQP, QNLI, STS-B, MRPC, RTE, SWAG

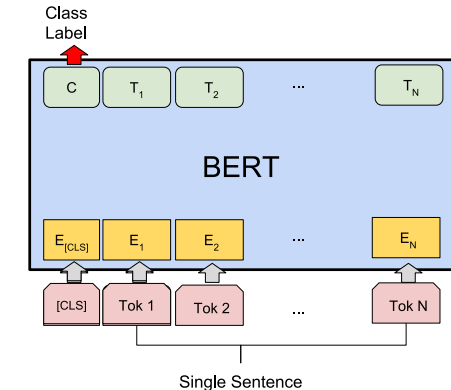

(b) Single Sentence Classification Tasks: SST-2, CoLA

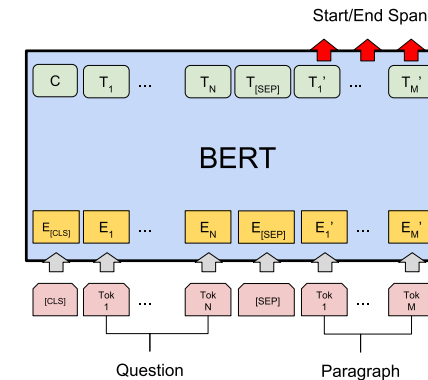

(c) Question Answering Tasks: SQuAD v1.1

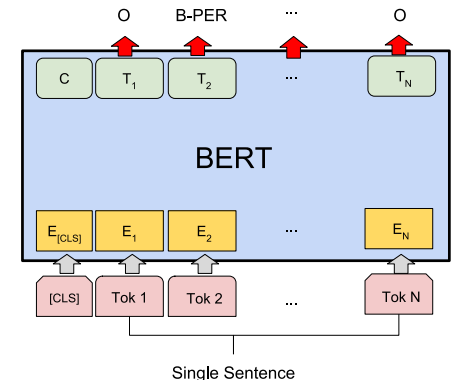

(d) Single Sentence Tagging Tasks: CoNLL-2003 NER

Figure 4 of "BERT: Pre-training of Deep Bidirectional Transformers for Language Understanding", <https://arxiv.org/abs/1810.04805>

BERT – Results

For finetuning, dropout 0.1 is used, usually very small number of epochs (2-4) suffice, and a good learning rate is usually one of $5e-5$, $3e-5$, $2e-5$.

System	MNLI-(m/mm) 392k	QQP 363k	QNLI 108k	SST-2 67k	CoLA 8.5k	STS-B 5.7k	MRPC 3.5k	RTE 2.5k	Average
Pre-OpenAI SOTA	80.6/80.1	66.1	82.3	93.2	35.0	81.0	86.0	61.7	74.0
BiLSTM+ELMo+Attn	76.4/76.1	64.8	79.8	90.4	36.0	73.3	84.9	56.8	71.0
OpenAI GPT	82.1/81.4	70.3	87.4	91.3	45.4	80.0	82.3	56.0	75.1
BERT _{BASE}	84.6/83.4	71.2	90.5	93.5	52.1	85.8	88.9	66.4	79.6
BERT _{LARGE}	86.7/85.9	72.1	92.7	94.9	60.5	86.5	89.3	70.1	82.1

Table 1: GLUE Test results, scored by the evaluation server (<https://gluebenchmark.com/leaderboard>). The number below each task denotes the number of training examples. The “Average” column is slightly different than the official GLUE score, since we exclude the problematic WNLI set.⁸ BERT and OpenAI GPT are single-model, single task. F1 scores are reported for QQP and MRPC, Spearman correlations are reported for STS-B, and accuracy scores are reported for the other tasks. We exclude entries that use BERT as one of their components.

Table 1 of "BERT: Pre-training of Deep Bidirectional Transformers for Language Understanding", <https://arxiv.org/abs/1810.04805>

System	Dev		Test	
	EM	F1	EM	F1
Top Leaderboard Systems (Dec 10th, 2018)				
Human	-	-	82.3	91.2
#1 Ensemble - nlnet	-	-	86.0	91.7
#2 Ensemble - QANet	-	-	84.5	90.5
Published				
BiDAF+ELMo (Single)	-	85.6	-	85.8
R.M. Reader (Ensemble)	81.2	87.9	82.3	88.5
Ours				
BERT _{BASE} (Single)	80.8	88.5	-	-
BERT _{LARGE} (Single)	84.1	90.9	-	-
BERT _{LARGE} (Ensemble)	85.8	91.8	-	-
BERT _{LARGE} (Sgl.+TriviaQA)	84.2	91.1	85.1	91.8
BERT _{LARGE} (Ens.+TriviaQA)	86.2	92.2	87.4	93.2

Table 2: SQuAD 1.1 results. The BERT ensemble is 7x systems which use different pre-training checkpoints and fine-tuning seeds.

Table 2 of "BERT: Pre-training of Deep Bidirectional Transformers for Language Understanding", <https://arxiv.org/abs/1810.04805>

System	Dev		Test	
	EM	F1	EM	F1
Top Leaderboard Systems (Dec 10th, 2018)				
Human	86.3	89.0	86.9	89.5
#1 Single - MIR-MRC (F-Net)	-	-	74.8	78.0
#2 Single - nlnet	-	-	74.2	77.1
Published				
unet (Ensemble)	-	-	71.4	74.9
SLQA+ (Single)	-	-	71.4	74.4
Ours				
BERT _{LARGE} (Single)	78.7	81.9	80.0	83.1

Table 3: SQuAD 2.0 results. We exclude entries that use BERT as one of their components.

Table 3 of "BERT: Pre-training of Deep Bidirectional Transformers for Language Understanding", <https://arxiv.org/abs/1810.04805>

System	Dev	Test
ESIM+GloVe	51.9	52.7
ESIM+ELMo	59.1	59.2
OpenAI GPT	-	78.0
BERT _{BASE}	81.6	-
BERT _{LARGE}	86.6	86.3
Human (expert) [†]	-	85.0
Human (5 annotations) [†]	-	88.0

Table 4: SWAG Dev and Test accuracies. [†]Human performance is measured with 100 samples, as reported in

Table 4 of "BERT: Pre-training of Deep Bidirectional Transformers for Language Understanding", <https://arxiv.org/abs/1810.04805>

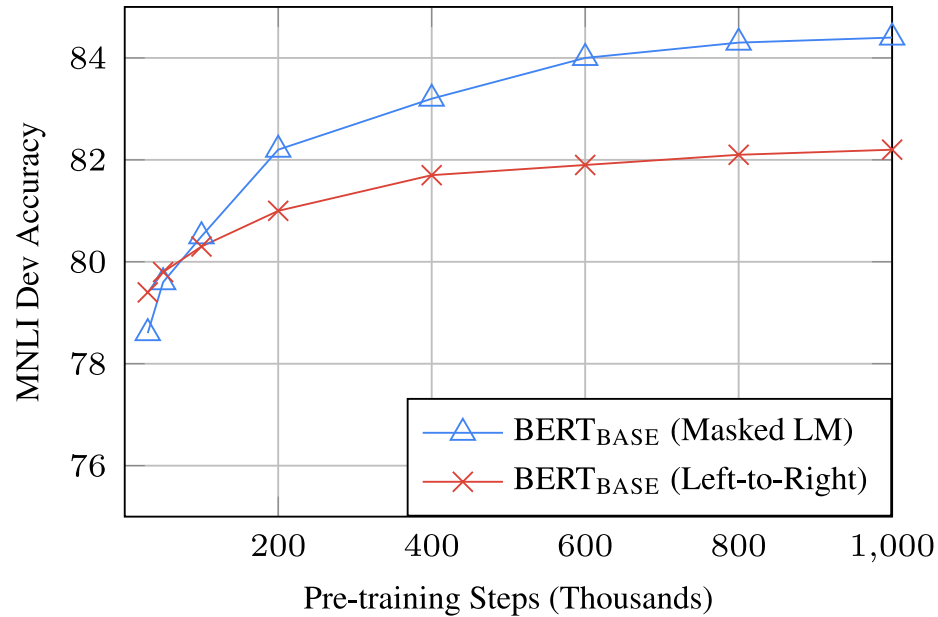

Figure 5: Ablation over number of training steps. This shows the MNL accuracy after fine-tuning, starting from model parameters that have been pre-trained for k steps. The x-axis is the value of k .

Figure 5 of "BERT: Pre-training of Deep Bidirectional Transformers for Language Understanding", <https://arxiv.org/abs/1810.04805>

Masking Rates			Dev Set Results		
MASK	SAME	RND	MNL	NER	
			Fine-tune	Fine-tune	Feature-based
80%	10%	10%	84.2	95.4	94.9
100%	0%	0%	84.3	94.9	94.0
80%	0%	20%	84.1	95.2	94.6
80%	20%	0%	84.4	95.2	94.7
0%	20%	80%	83.7	94.8	94.6
0%	0%	100%	83.6	94.9	94.6

Table 8: Ablation over different masking strategies.

Table 8 of "BERT: Pre-training of Deep Bidirectional Transformers for Language Understanding", <https://arxiv.org/abs/1810.04805>

The Multilingual BERT is pre-trained on 102-104 largest Wikipedias, including the Czech one. There are two versions, the *cased* one has WordPieces including case, and the *uncased* one with subwords all in lower case and *without diacritics*.

Even if only very small percentage of input sentences were Czech, it works surprisingly well for Czech NLP.

Furthermore, without any explicit supervision, mBERT is able to represent the input languages in a *shared* space, allowing cross-lingual transfer.

Consider a *reading comprehension* task, where for a given paragraph and a question an answer needs to be located in the paragraph.

Then training the model in English and then directly running it on a different language works comparably to translating the data to English and then back.

En	During what time period did the Angles migrate to Great Britain?	The name "England" is derived from the Old English name England [..] The Angles were one of the Germanic tribes that settled in Great Britain during the Early Middle Ages . [..] The Welsh name for the English language is "Saesneg"
De	Während welcher Zeitperiode migrierten die Angeln nach Großbritannien?	Der Name England leitet sich vom altenglischen Wort Engaland [..] Die Angeln waren ein germanischer Stamm, der das Land im Frühmittelalter besiedelte. [..] ein Verweis auf die weißen Klippen von Dover.
Ar	في أي حقبة زمنية هاجر الأنجل إلى بريطانيا العظمى؟	والتي تعني "الرض الأنجل". والأنجل كانت واحدة، Engaland، مشتق اسم "الانجل" من الكلمة الإنجليزية القديمة من القبائل الجرمانية التي استقرت في إنجلترا خلال العصور الوسطى . [..] وقد سماها العرب قديماً الإنكتار
Vi	Trong khoảng thời gian nào người Angles di cư đến Anh?	Tên gọi của Anh trong tiếng Việt bắt nguồn từ tiếng Trung. [..] Người Angle là một trong những bộ tộc German định cư tại Anh trong Thời đầu Trung Cổ . [..] đường như nó liên quan tới phong tục gọi người German tại Anh là Angli Saxones hay Anh - Sachsen.
En	What are the names given to the campuses on the east side of the land the university sits on?	The campus is in the residential area of Westwood [..] The campus is informally divided into North Campus and South Campus , which are both on the eastern half of the university's land. [..] The campus includes [..] a mix of architectural styles.
Es	¿Cuáles son los nombres dados a los campus ubicados en el lado este del recinto donde se encuentra la universidad?	El campus incluye [..] una mezcla de estilos arquitectónicos. Informalmente está dividido en Campus Norte y Campus Sur , ambos localizados en la parte este del terreno que posee la universidad. [..] El Campus Sur está enfocado en la ciencias físicas [..] y el Centro Médico Ronald Reagan de UCLA.
Zh	位于大学占地东半部的校园名称是什么？	整个校园被不正式地分为 南北两个校园 ，这两个校园都位于大学占地的东半部。北校园是原校园的中心，建筑以意大利文艺复兴时代建筑闻名，其中的包威尔图书馆 (Powell Library) 成为好莱坞电影的最佳拍摄场景。 [..] 这个广场曾在许多电影中出现。
Hi	विश्वविद्यालय जहाँ स्थित है, उसके पूर्वी दिशा में बने परिसरों को क्या नाम दिया गया है?	जब 1919 में यूसीएलए ने अपना नया परिसर खोला, तब इसमें चार इमारतें थीं। [..] परिसर अनौपचारिक रूप से उत्तरी परिसर और दक्षिणी परिसर में विभाजित है, जो दोनों विश्वविद्यालय की जमीन के पूर्वी हिस्से में स्थित हैं। [..] दक्षिणी परिसर में भौतिक विज्ञान, जीव विज्ञान, इंजीनियरिंग, मनोविज्ञान, गणितीय विज्ञान, सभी स्वास्थ्य से संबंधित क्षेत्र और यूएलसीए मेडिकल सेंटर स्थित है।

Figure 2 of "MLQA: Evaluating Cross-lingual Extractive Question Answering", <https://arxiv.org/abs/1910.07475>

F1 / EM	en	es	de	ar	hi	vi	zh
BERT-Large	80.2 / 67.4	-	-	-	-	-	-
Multilingual-BERT	77.7 / 65.2	64.3 / 46.6	57.9 / 44.3	45.7 / 29.8	43.8 / 29.7	57.1 / 38.6	57.5 / 37.3
XLM	74.9 / 62.4	68.0 / 49.8	62.2 / 47.6	54.8 / 36.3	48.8 / 27.3	61.4 / 41.8	61.1 / 39.6
Translate test, BERT-L	-	65.4 / 44.0	57.9 / 41.8	33.6 / 20.4	23.8 / 18.9*	58.2 / 33.2	44.2 / 20.3
Translate train, M-BERT	-	53.9 / 37.4	62.0 / 47.5	51.8 / 33.2	55.0 / 40.0	62.0 / 43.1	61.4 / 39.5
Translate train, XLM	-	65.2 / 47.8	61.4 / 46.7	54.0 / 34.4	50.7 / 33.4	59.3 / 39.4	59.8 / 37.9

Table 5 of "MLQA: Evaluating Cross-lingual Extractive Question Answering", <https://arxiv.org/abs/1910.07475>

The *next sentence prediction* was originally hypothesized to be an important factor during training of the BERT model, as indicated by ablation experiments. However, later experiments indicated removing it might improve results.

The RoBERTa authors therefore performed the following experiments:

- SEGMENT-PAIR: pair of segments with at most 512 tokens in total;
- SENTENCE-PAIR: pair of *natural sentences*, usually significantly shorter than 512 tokens;
- FULL-SENTENCES: just one segment on input with 512 tokens, can cross document boundary;
- DOC-SENTENCES: just one segment on input with 512 tokens, cannot cross document boundary.

Model	SQuAD 1.1/2.0	MNLI-m	SST-2	RACE
<i>Our reimplementaion (with NSP loss):</i>				
SEGMENT-PAIR	90.4/78.7	84.0	92.9	64.2
SENTENCE-PAIR	88.7/76.2	82.9	92.1	63.0
<i>Our reimplementaion (without NSP loss):</i>				
FULL-SENTENCES	90.4/79.1	84.7	92.5	64.8
DOC-SENTENCES	90.6/79.7	84.7	92.7	65.6
BERT _{BASE}	88.5/76.3	84.3	92.8	64.3
XLNet _{BASE} (K = 7)	-/81.3	85.8	92.7	66.1
XLNet _{BASE} (K = 6)	-/81.0	85.6	93.4	66.7

Table 2 of "RoBERTa: A Robustly Optimized BERT Pretraining Approach", <https://arxiv.org/abs/1907.11692>

RoBERTa – Larger Batches

BERT is trained for 1M steps with a learning rate of $1e-4$.

The RoBERTa authors also considered larger batches (with linearly larger learning rate).

bsz	steps	lr	ppl	MNLI-m	SST-2
256	1M	$1e-4$	3.99	84.7	92.7
2K	125K	$7e-4$	3.68	85.2	92.9
8K	31K	$1e-3$	3.77	84.6	92.8

Table 3: Perplexity on held-out training data (*ppl*) and development set accuracy for base models trained over BOOKCORPUS and WIKIPEDIA with varying batch sizes (*bsz*). We tune the learning rate (*lr*) for each setting. Models make the same number of passes over the data (epochs) and have the same computational cost.

Table 3 of "RoBERTa: A Robustly Optimized BERT Pretraining Approach", <https://arxiv.org/abs/1907.11692>

The RoBERTa model, **R**obustly **o**ptimized **BERT** approach, is trained with dynamic masking, FULL-SENTENCES without NSP, large 8k minibatches and byte-level BPE with 50k subwords.

Model	data	bsz	steps	SQuAD (v1.1/2.0)	MNLI-m	SST-2
RoBERTa						
with BOOKS + WIKI	16GB	8K	100K	93.6/87.3	89.0	95.3
+ additional data (§3.2)	160GB	8K	100K	94.0/87.7	89.3	95.6
+ pretrain longer	160GB	8K	300K	94.4/88.7	90.0	96.1
+ pretrain even longer	160GB	8K	500K	94.6/89.4	90.2	96.4
BERT _{LARGE}						
with BOOKS + WIKI	13GB	256	1M	90.9/81.8	86.6	93.7
XLNet _{LARGE}						
with BOOKS + WIKI	13GB	256	1M	94.0/87.8	88.4	94.4
+ additional data	126GB	2K	500K	94.5/88.8	89.8	95.6

Table 4: Development set results for RoBERTa as we pretrain over more data (16GB \rightarrow 160GB of text) and pretrain for longer (100K \rightarrow 300K \rightarrow 500K steps). Each row accumulates improvements from the rows above. RoBERTa matches the architecture and training objective of BERT_{LARGE}. Results for BERT_{LARGE} and XLNet_{LARGE} are from Devlin et al. (2019) and Yang et al. (2019), respectively. Complete results on all GLUE tasks can be found in the Appendix.

Table 4 of "RoBERTa: A Robustly Optimized BERT Pretraining Approach", <https://arxiv.org/abs/1907.11692>

RoBERTa Results

	MNLI	QNLI	QQP	RTE	SST	MRPC	CoLA	STS	WNLI	Avg
<i>Single-task single models on dev</i>										
BERT _{LARGE}	86.6/-	92.3	91.3	70.4	93.2	88.0	60.6	90.0	-	-
XLNet _{LARGE}	89.8/-	93.9	91.8	83.8	95.6	89.2	63.6	91.8	-	-
RoBERTa	90.2/90.2	94.7	92.2	86.6	96.4	90.9	68.0	92.4	91.3	-
<i>Ensembles on test (from leaderboard as of July 25, 2019)</i>										
ALICE	88.2/87.9	95.7	90.7	83.5	95.2	92.6	68.6	91.1	80.8	86.3
MT-DNN	87.9/87.4	96.0	89.9	86.3	96.5	92.7	68.4	91.1	89.0	87.6
XLNet	90.2/89.8	98.6	90.3	86.3	96.8	93.0	67.8	91.6	90.4	88.4
RoBERTa	90.8/90.2	98.9	90.2	88.2	96.7	92.3	67.8	92.2	89.0	88.5

Table 5: Results on GLUE. All results are based on a 24-layer architecture. BERT_{LARGE} and XLNet_{LARGE} results are from Devlin et al. (2019) and Yang et al. (2019), respectively. RoBERTa results on the development set are a median over five runs. RoBERTa results on the test set are ensembles of *single-task* models. For RTE, STS and MRPC we finetune starting from the MNLI model instead of the baseline pretrained model. Averages are obtained from the GLUE leaderboard.

Table 5 of "RoBERTa: A Robustly Optimized BERT Pretraining Approach", <https://arxiv.org/abs/1907.11692>

Model	SQuAD 1.1		SQuAD 2.0	
	EM	F1	EM	F1
<i>Single models on dev, w/o data augmentation</i>				
BERT _{LARGE}	84.1	90.9	79.0	81.8
XLNet _{LARGE}	89.0	94.5	86.1	88.8
RoBERTa	88.9	94.6	86.5	89.4
<i>Single models on test (as of July 25, 2019)</i>				
XLNet _{LARGE}			86.3 [†]	89.1 [†]
RoBERTa			86.8	89.8
XLNet + SG-Net Verifier			87.0[†]	89.9[†]

Table 6 of "RoBERTa: A Robustly Optimized BERT Pretraining Approach", <https://arxiv.org/abs/1907.11692>

Model	Accuracy	Middle	High
<i>Single models on test (as of July 25, 2019)</i>			
BERT _{LARGE}	72.0	76.6	70.1
XLNet _{LARGE}	81.7	85.4	80.2
RoBERTa	83.2	86.5	81.3

Table 7: Results on the RACE test set. BERT_{LARGE} and XLNet_{LARGE} results are from Yang et al. (2019).

Table 7 of "RoBERTa: A Robustly Optimized BERT Pretraining Approach", <https://arxiv.org/abs/1907.11692>

The Transformer architecture has been spreading and has become almost omnipresent in tasks where data is available in abundance, in which case it usually delivers superior performance.

Language Models

- GPT: Transformer decoder-only model, 2018, ~150M parameters
- GPT-2: Transformer decoder-only model, 2019, ~1.5B parameters
- GPT-3: Transformer decoder-only model, May 2020, ~175B parameters
- Gopher: Transformer decoder-only model, Dec 2021, ~280B parameters
- XGLM: multilingual Transformer decoder-only model, Dec 2021, ~7.5B parameters
 - 30 languages from 16 language families
- Megatron-Turing NLP: Transformer decoder-only model, Jan 2022, ~530B parameters
 - trained using 2240 A100
- PaLM: Transformer decoder-only model, Apr 2022, ~580B parameters
 - trained using 6144 TPUv4
 - 22% training data non-English

Explaining a Joke

I will explain these jokes:

(1) The problem with kleptomaniacs is that they always take things literally.

Explanation: This joke is wordplay. Someone who "takes things literally" is someone who doesn't fully understand social cues and context, which is a negative trait. But the definition of kleptomania is someone who literally takes things.

(2) Always borrow money from a pessimist. They'll never expect it back.

Explanation: Most people expect you to pay them back when you borrow money, however a pessimist is someone who always assumes the worst, so if you borrow money from them, they will expect that you won't pay them back anyways.

Input: I was supposed to start writing the paper at 5:00 PM. But then I started playing with this cool new language model for 10 minutes. 10 minutes later, it's suddenly 9:30 PM!

Model Output: This joke is about how time flies when you're having fun. The person was supposed to start writing a paper at 5:00 PM, but they started playing with a language model instead. They thought they were only playing with it for 10 minutes, but it was actually 4.5 hours.

Input: I think I understand why me and my partner are such a good match. I get excited when I smell food and become super alert when the doorbell rings. My girlfriend Shelley becomes ecstatic when she sees a person who she just saw 5 hours ago.

Model Output: This joke is about dogs. Dogs get excited when they smell food and when the doorbell rings. The girlfriend is excited to see someone she just saw 5 hours ago, which is a trait of dogs.

Input: I was going to fly to visit my family on April 6th. My mom said "Oh great, your step dad's poetry reading is that night!" So now I'm flying in on April 7th.

Model Output: The joke is that the speaker's mother is trying to get them to go to their step dad's poetry reading, but the speaker doesn't want to go, so they are changing their flight to the day after the poetry reading.

Input: I tried 10,000 random restarts of my neural network, but I was accused of overfitting. I guess no good seed goes unpunished.

Model Output: This joke is a pun. A neural network is a computer program that can learn from data. A "seed" is a number that is used to initialize a random number generator. A "good seed" is a number that produces a good random number generator. The phrase "no good deed goes unpunished" means that if you do something good, you will be punished for it.

Input: Reading "War and Peace" doesn't scare me. I once had to review the CL for my intern's whole project on his final day!

Model Output: 'War and Peace' is a very long book, so reading it is a daunting task. However, the speaker is saying they had to review the code for their intern's project on their final day, which is even more daunting.

Input: What's the difference between a zebra and an umbrella? One is a striped animal related to horses, another is a device you use to stop the rain from falling on you.

Model Output: This joke is an anti-joke. The joke is that the answer is obvious, and the joke is that you were expecting a funny answer.

Figure 19 of "PaLM: Scaling Language Modeling with Pathways", <https://arxiv.org/abs/2204.02311>

Pre-trained Encoder-Decoder Models

Various pre-trained encoder-decoder models are available:

- BART, 2019, ~200M parameters
- T5, Oct 2019, up to ~11B parameters
 - REALM, Feb 2020, ~330M, uses explicit retrieval from a large knowledge base

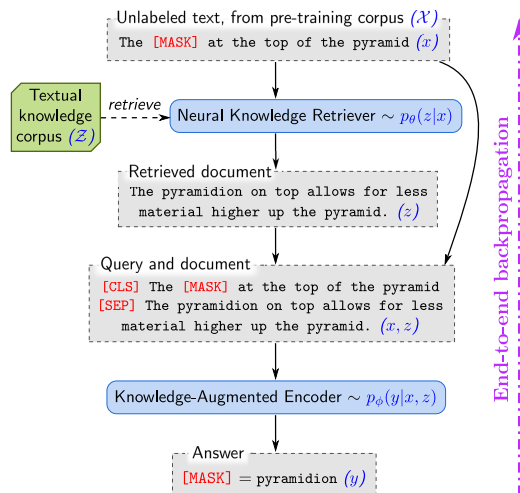

Figure 1 of "REALM: Retrieval-Augmented Language Model Pre-Training", <https://arxiv.org/pdf/2002.05202.pdf>

- mT5, Oct 2020, ~100 languages, up to ~13B parameters
 - sizes small (300M), base (582M), large (1.23B), xl (3.74B), xxl (12.9B)
- ByT5, May 2021, byte-based, ~100 languages, same sizes as mT5

Processing Images with Transformers

In Oct 2020, an influential paper

An Image is Worth 16x16 Words: Transformers for Image Recognition at Scale

proposed processing of images using ViT a variant of the Transformers architecture (**V**isual **T**ransformer)

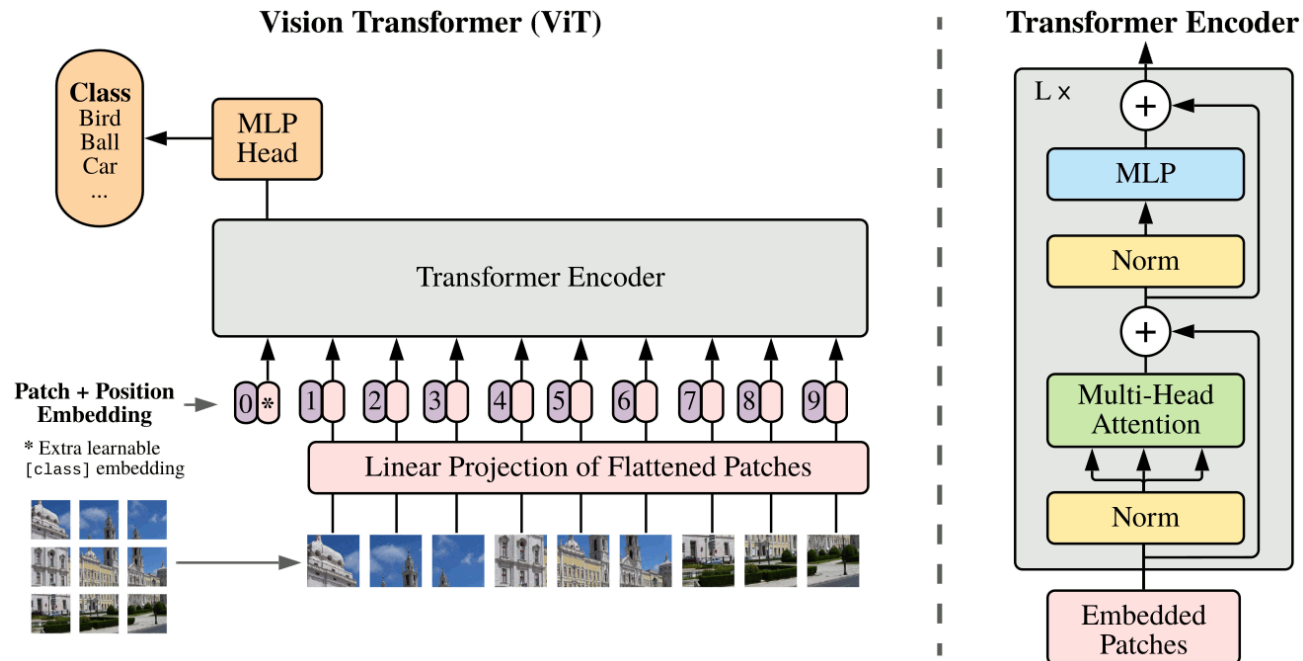

Figure 1 of "An Image is Worth 16x16 Words: Transformers for Image Recognition at Scale", <https://arxiv.org/abs/2010.11929>

Processing Images with Transformers

The ViT architecture surpasses convolutional models like EfficientNet when pre-trained on very large data (~300M images); however, training only on ImageNet1k delivered worse results (77.9% top-1 accuracy).

An improved training with a variety of augmentation (DeiT architecture, Dec 2020) resulted in performance close to EfficientNet when trained only on ImageNet1k data (83.1% vs 84.7% top-1 accuracy).

DeiT III: Revenge of the ViT (Apr 2022) has presented simplified training procedure, achieving results analogous to EfficientNetV2 on ImageNet1k (85.2% vs 85.7% top-1 accuracy) and ImageNet21k (87.2% vs 87.3% top-1 accuracy).

Processing Images with Transformers

When data is limited (“only” 1M images), the best approach to train a ViT seems to be a BERT-like masking, which was proposed in Nov 2021 paper

Masked Autoencoders Are Scalable Vision Learners.

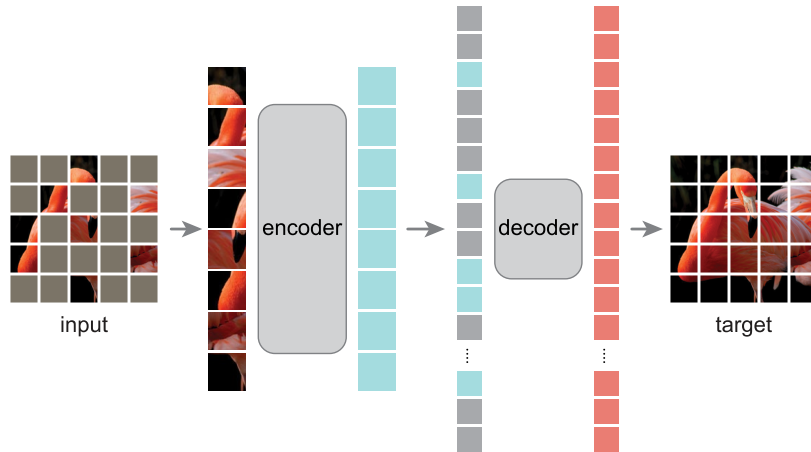

Figure 1 of "Masked Autoencoders Are Scalable Vision Learners", <https://arxiv.org/abs/2111.06377>

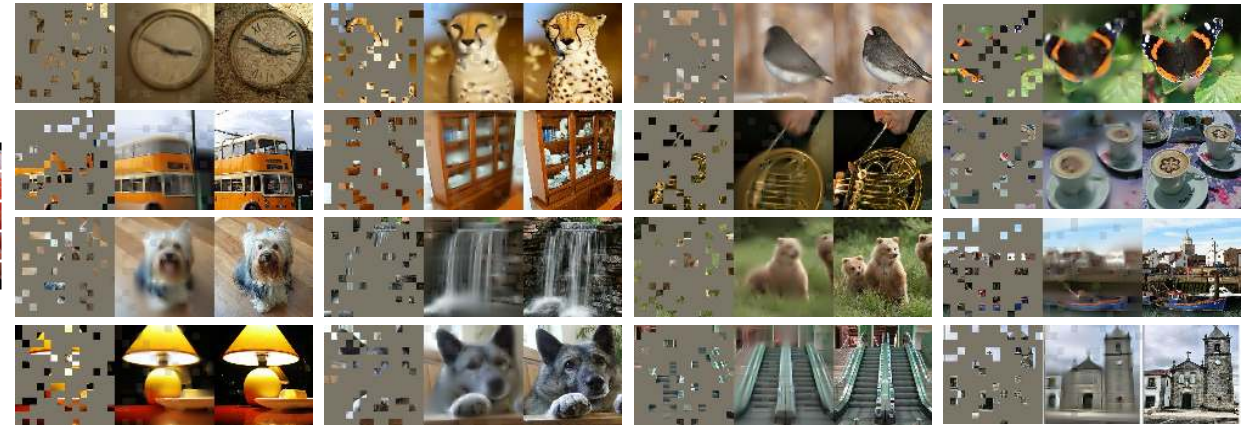

Figure 2 of "Masked Autoencoders Are Scalable Vision Learners", <https://arxiv.org/abs/2111.06377>

This MAE architecture reaches 86.9% top-1 accuracy on ImageNet1k-only training on images of size 224, and 87.8% on images of size 448.